

SPD8811B

1-Line, Bi-directional, Thyristor Surge Suppressors

<http://www.sh-willsemi.com>

Descriptions

The SPD8811B is a bi-directional TSS (Thyristor Surge Suppressors) which can provide ESD protection for IC. It is specifically designed to protect telecom equipments from damaging overvoltage transients.

The SPD8811B is used to enable equipments to meet various regulatory requirements including, ITU-T K.20, K.21 and IEC 61000-4-5

The SPD8811B is available in SMB package. Standard products are Pb-free and Halogen-free.

Features

- Peak off-state voltage: $\pm 58V$ Max
- Excellent capability of absorbing transient surge
- Quick response to surge voltage
- Eliminate voltage overshoot caused by fast-rising transients
- Low leakage current:
- Solid-state silicon technology, non degenerative

Applications

- Audio/Video line
- Network and telecom
- Data lines and security systems
- Serial ports
- BNC interface
- DVR



SMB (DO-214AA)

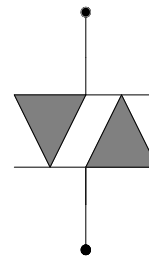

Schematic Diagram

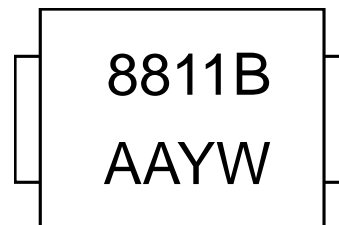

AA = Device code
 Y = Year code
 W = Week code

Marking (Top View)

Order information

Device	Package	Shipping
SPD8811B-2/TR	SMB	3000/Tape&Reel

Electrical characteristics ($T_A=25^\circ\text{C}$, unless otherwise noted)

Part Number	V_{DRM}	I_{DRM}	V_S	$V_{\text{BR}}^{1)}$	I_S	I_H	V_T	I_T	$C_o^{2)}$
	V	μA	V	V	mA	mA	V	A	pF
		Max.	Max.	Min.		Max.	Max.		Typ.
SPD8811B	58	1	77	60	800	150	4	2.2	50

Notes:

- 1) V_{BR} is measured at $I_{\text{BR}}=1\text{mA}$.
- 2) Off-state capacitance is measured at $f = 1\text{MHz}$, $V_{\text{DC}} = 2\text{V}$.

Surge Ratings

Part Number	$8/20\mu\text{s}^{1)}$	$5/320\mu\text{s}^{1)}$	$2/10\mu\text{s}^{1)}$
	$1.2/50\mu\text{s}^{2)}$	$10/700\mu\text{s}^{2)}$	$2/10\mu\text{s}^{2)}$
SPD8811B	400 A	6000 V	500 A

Notes:

- 1) Current waveform.
- 2) Voltage waveform.

Thermal considerations

Parameter	Symbol	Rating	Unit
Operation junction temperature	T_J	-40~150	$^{\circ}\text{C}$
Storage temperature	T_{STG}	-55~150	$^{\circ}\text{C}$
Lead temperature	T_L	260	$^{\circ}\text{C}$
Junction to ambient thermal resistance	$R_{\theta\text{JA}}$	90	$^{\circ}\text{C/W}$

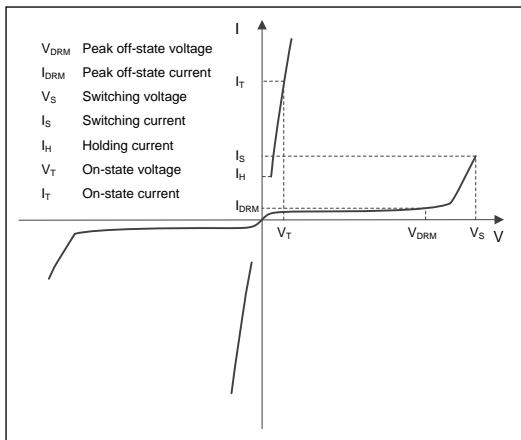
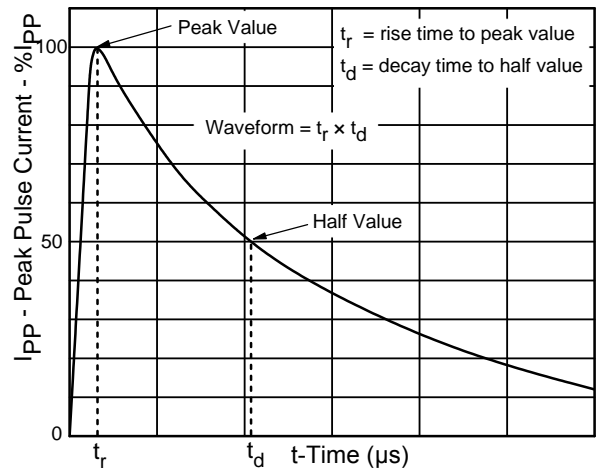
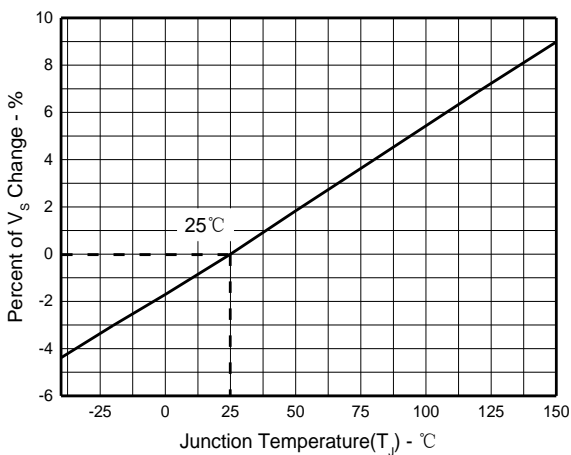
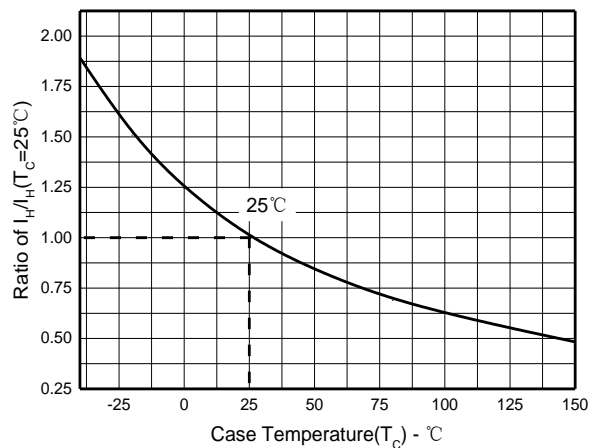
Typical characteristics ($T_A=25^{\circ}\text{C}$, unless otherwise noted)

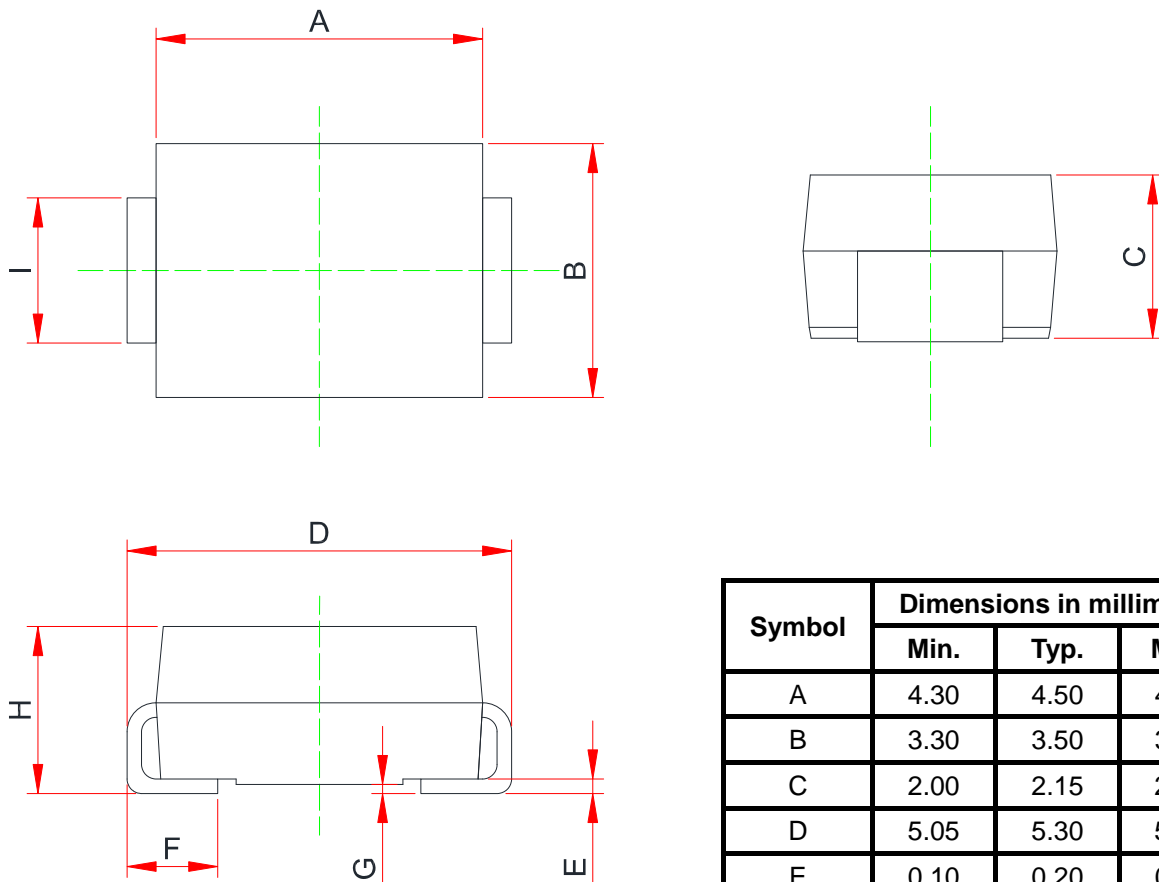
Definitions of electrical characteristics

Peak pulse current waveform

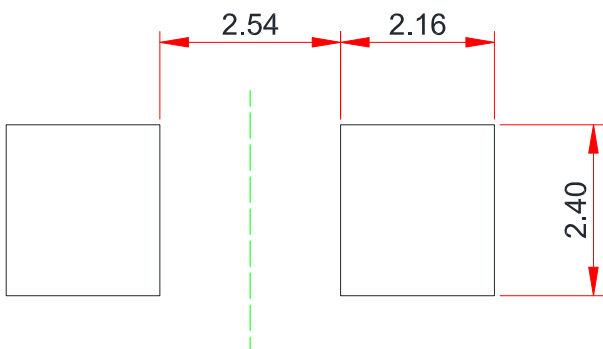
Normalized V_S Change vs. Junction Temperature

Normalized Holding Current vs. Case Temperature

Package outline dimensions
SMB

Symbol	Dimensions in millimeter		
	Min.	Typ.	Max.
A	4.30	4.50	4.70
B	3.30	3.50	3.70
C	2.00	2.15	2.30
D	5.05	5.30	5.55
E	0.10	0.20	0.30
F	0.95	1.25	1.55
G	0.20 Max.		
H	2.10	2.30	2.50
I	1.85	2.00	2.15

Recommend land pattern (Unit: mm)

Notes:

This recommended land pattern is for reference purposes only. Please consult your manufacturing group to ensure your PCB design guidelines are met.