

WS3210

Over-Voltage Protection Load Switch

<http://www.sh-willsemi.com>

Descriptions

The WS3210 features a low R_{ON} internal High Voltage Switch and an input range of absolute maximum 30V. An internal input clamp is capable of shunting surge voltage >80V, protecting downstream components and enhancing system robustness. The WS3210 features Over-Voltage Protection (OVP) that shuts off the internal Switch if input voltage exceeds the Fixed OVP threshold. The off-state Switch can disconnect the input pin to output pin and protect output from the input high voltage stress. Integrated Over-Temperature Protection (OTP) also shuts off the Switch to protect the device.

The WS3210 is available in 1.4mm x 1.4mm WLCSP-9B package. Standard product is Pb-free and Halogen-free.

Features

- Absolute Maximum Input Voltage : 30V
- Surge Protection : >80V
- Low R_{ON} Switch (@ $V_{IN}=5V$) : 45m Ω
- Fixed OVP Threshold
 - WS3210C : 5.85V
 - WS3210CB : 10.5V
 - WS3210CD : 14.0V
- Fast OVP Response : 100ns
- Thermal Shutdown Protection
- Robust ESD Protection
 - Human Body Model (HBM) : 8000V
 - Machine Model (MM) : 800V

Applications

- Mobile Handsets and Tablets
- Portable Media Players
- Peripherals

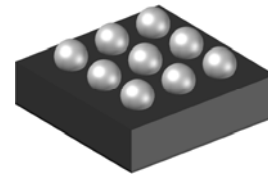

WLCSP-9B (Bottom View)

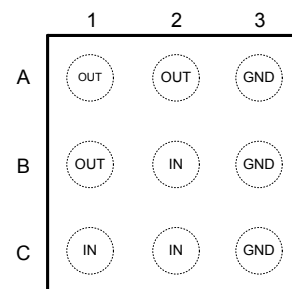

Pin Configuration (Top View)

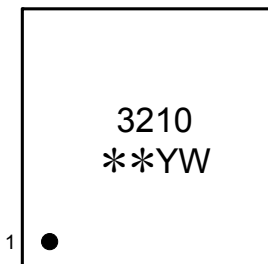

Marking

- 3210** = Device code
- **** = Special code
- Y** = Year code
- W** = Week Code

Order information

Device	Package	Mark	Shipping
WS3210C-9/TR	WLCSP-9B	WC	3000/reel&Tape
WS3210CB-9/TR	WLCSP-9B	CB	3000/reel&Tape
WS3210CD-9/TR	WLCSP-9B	CD	3000/reel&Tape

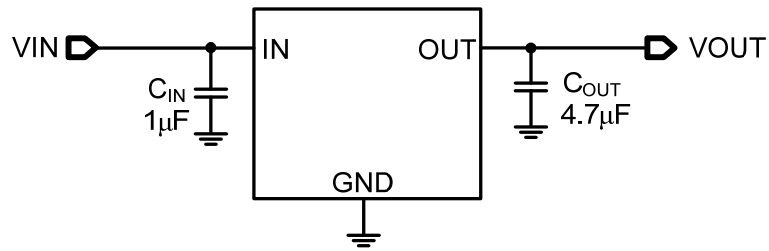
Typical Applications

Pin Descriptions

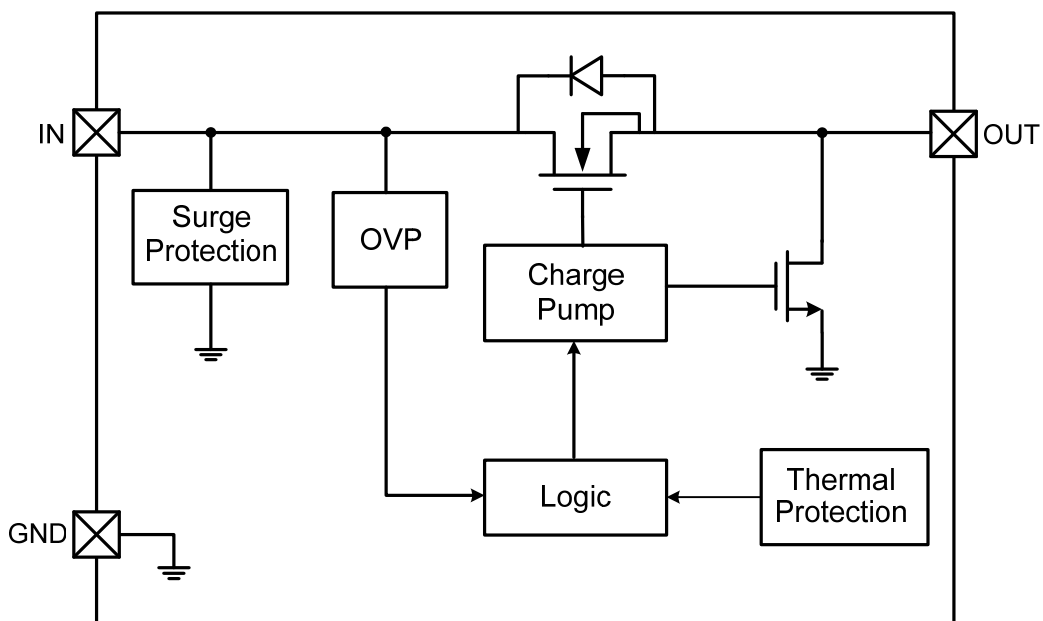
Pin Number	Symbol	Descriptions
1C, 2B, 2C	IN	Switch Input Pin and Device Power Supply.
1A, 1B, 2A	OUT	Switch Output Pin to Load.
3A, 3B, 3C	GND	Device Ground Pin.

Block Diagram

Absolute maximum ratings

Parameter	Symbol	Value	Unit
V_IN voltage range	V _{IN}	-0.3~30	V
V_OUT voltage range	V _{OUT}	-0.3~16	V
Switch I/O Continuous Current	I _{IN}	3	A
Switch FET Body Diode Continuous Current	I _{DIODE}	1.5	A
Junction temperature	T _J	150	°C
Lead temperature(Soldering, 10s)	T _L	260	°C
Storage temperature	T _{stg}	-55~150	°C
ESD Ratings	HBM	8000	V
	MM	800	V

These are stress ratings only. Stresses exceeding the range specified under “Absolute Maximum Ratings” may cause substantial damage to the device. Functional operation of this device at other conditions beyond those listed in the specification is not implied and prolonged exposure to extreme conditions may affect device reliability.

Recommend Operating Conditions

Parameter	Symbol	Value	Unit
VIN supply input voltage range	V _{cc}	3.2~28, typical=5	V
		3.2~28, typical=9	
		3.2~28, typical=12	
Operating ambient temperature	T _A	-40~85	°C
Thermal Resistance	R _{θJA}	95	°C/W

Electrical Characteristics ($T_A = 25^\circ\text{C}$, $V_{IN} = 5\text{V}$, $C_{IN} = 1\mu\text{F}$, $C_{OUT} = 4.7\mu\text{F}$, for 5V application, unless otherwise noted)

Parameter	Symbol	Conditions	Min.	Typ.	Max.	Units
Basic Operation						
Quiescent Supply Current	I_Q	$V_{IN} = 5\text{V}$, No Load		135	200	μA
UVLO Threshold Voltage	V_{UVLO}	V_{IN} Rising		2.4	3.2	V
Start-up Delay Time	T_{START_DLY}	$V_{IN} = 0 \rightarrow 5\text{V}$ to Output ON		7.5		ms
Main Switch ON-Resistance	R_{ON}	$V_{IN} = 5\text{V}$, $I_{OUT} = 1\text{A}$		45		$\text{m}\Omega$
Surge and Over-Voltage Protection						
Surge Voltage Protection	V_{SURGE}			88		V
VIN OVP Threshold	V_{OVP}	V_{IN} Rising, WS3210C	5.60	5.85	6.05	V
		V_{IN} Rising, WS3210CB	10.0	10.5	11.0	V
		V_{IN} Rising, WS3210CD	13.5	14.0	14.5	V
OVP Response Time	t_{OVP}	$V_{IN} = 5 \rightarrow 10\text{V}$ (WS3210C)		100		ns
OVP Hysteresis Voltage	V_{HYS_OVP}	V_{IN} Falling		0.1		V
OVP Recovery Time	t_{R_OVP}	$V_{IN} = 6.5 \rightarrow 5\text{V}$ (WS3210C)		7.5		ms
Output discharge resistance	R_{DCHG}	$V_{IN} = 6.1\text{V}$, $V_{OUT} = 5\text{V}$ (WS3210C)		120		Ω
Thermal Protection						
Over-Temperature Protection Threshold	T_{SD}			140		$^\circ\text{C}$
Over-Temperature Protection Hysteresis	T_{HYS}			20		$^\circ\text{C}$

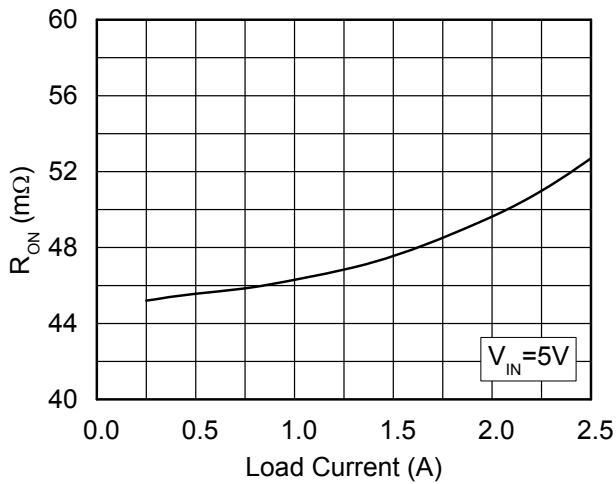
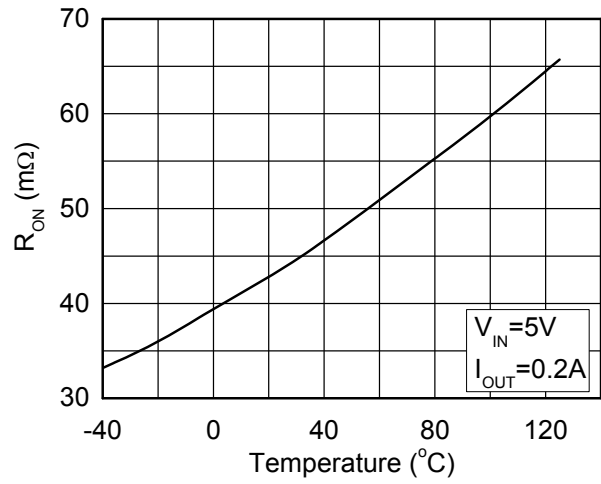
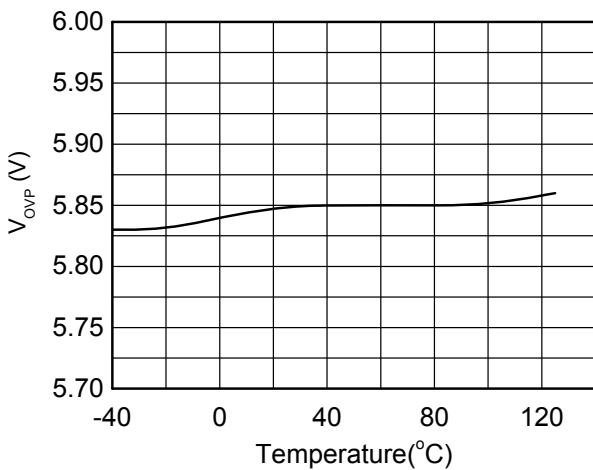
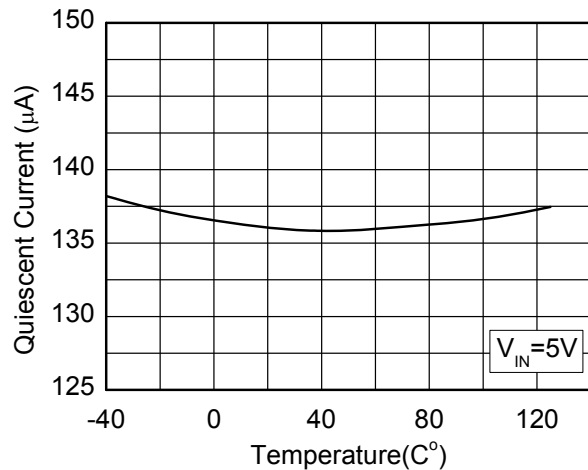
Typical Characteristics ($T_A=25^\circ\text{C}$, for 5V application, unless otherwise noted)

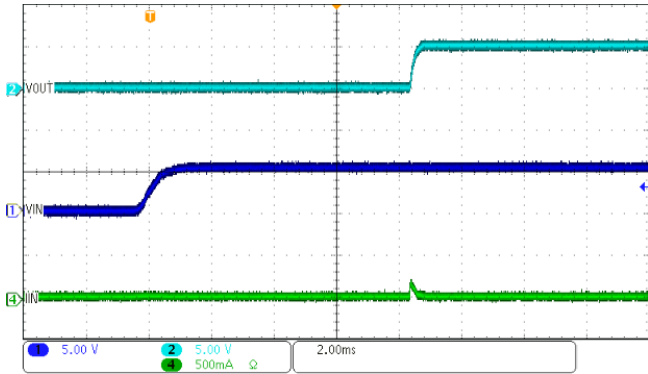
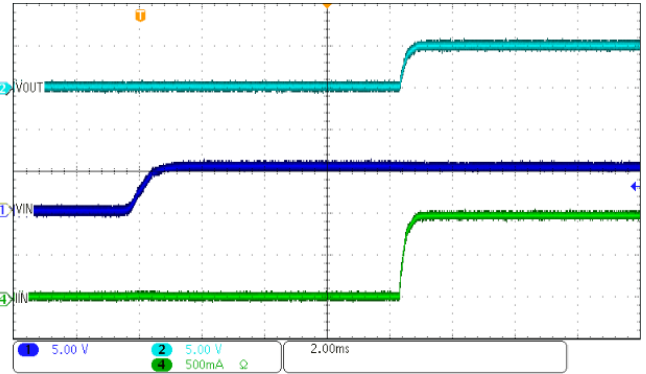
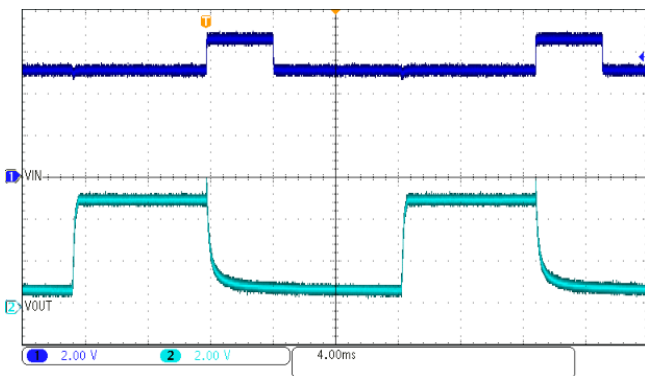
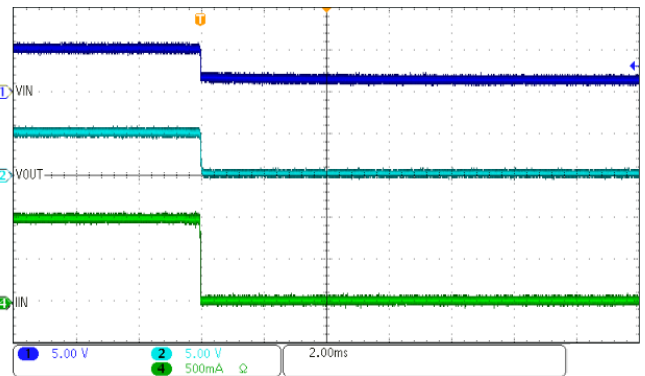
ON Resistance vs. Load Current

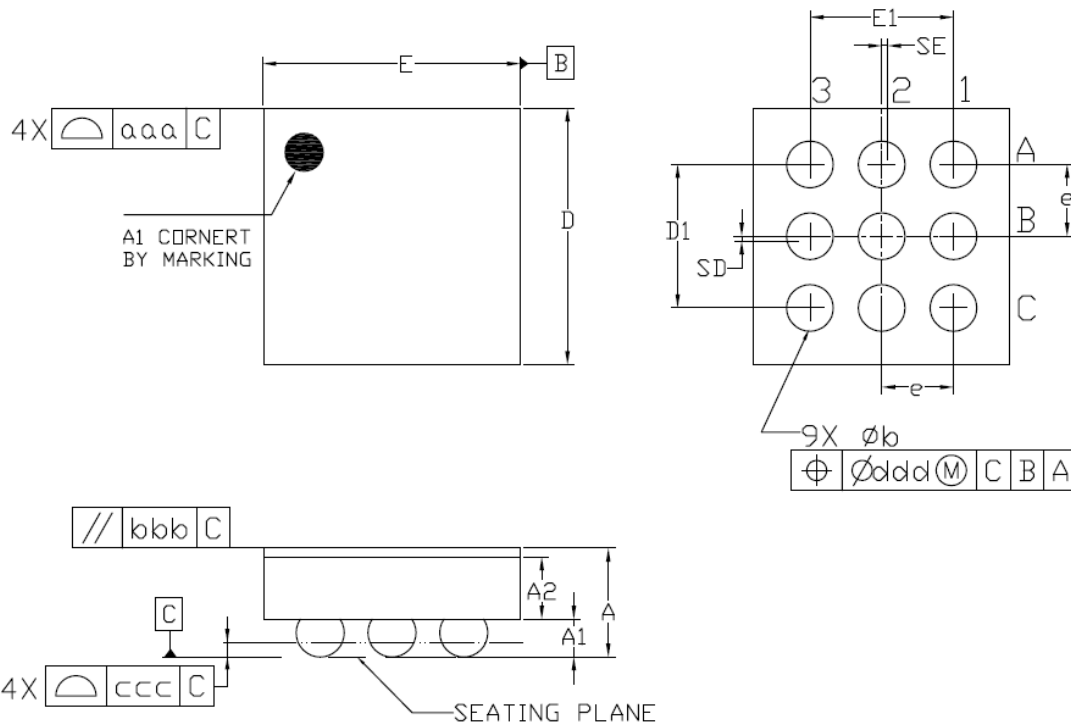
ON Resistance vs. Temperature

OVP Threshold vs. Temperature

Quiescent Current vs. Temperature

Power-On with No Load

Power-On with $R_L=5\Omega$

OVP and Recovery from OVP

Power-Off with $R_L=5\Omega$

Package Outline Dimensions

Notes

1. ALL DIMENSIONS ARE IN MILLIMETERS (ANGLES IN DEGREES).
2. DIMENSIONING AND TOLERANCING PER ANSI Y14.5M-1994.

Dimensional Ref.			
REF.	Min.	Nom.	Max.
A	0.536	0.586	0.636
A1	0.185	0.210	0.235
A2	0.331	0.356	0.381
D	1.385	1.400	1.415
E	1.385	1.400	1.415
D1	0.750	0.800	0.850
E1	0.750	0.800	0.850
b	0.220	0.260	0.300
e	0.400 BSC		
SD	0.000 BSC		
SE	0.000 BSC		
Tol. of Form & Position			
aaa	0.10		
bbb	0.10		
ccc	0.05		
ddd	0.05		