

WD3126

1A output current, Adj. Output voltage, Boost Converter with 2.75A Main-Switch

[Http://www.sh-willsemi.com](http://www.sh-willsemi.com)

Descriptions

The WD3126 is a high efficiency, peak current control mode DC-DC boost converter. It supports up to 1A output current with an integrated low $R_{DS(ON)}$ (130m Ω) N-channel MOSFET and cycle by cycle current limit protection. The device can provide a USB 5V compliant power output from a single Li-ion battery.



SOT-23-6L

The boost converter runs in Pulse-Width Modulation (PWM) mode, at 1MHz fixed switching frequency to reduce output ripple, improve conversion efficiency. It allows for the use of small external components. At light load currents the converter enters Skipping Mode to maintain a high efficiency over a wide load current range. The build-in soft start circuitry minimizes the inrush current at start-up. Internal compensation network require only boost inductor, schottky diode, and input and output capacitors for WD3126, save PCB area.

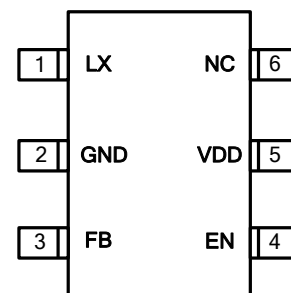

Pin configuration (Top view)

The WD3126 is available in SOT-23-6L package. Standard product is Pb-free and Halogen-free.

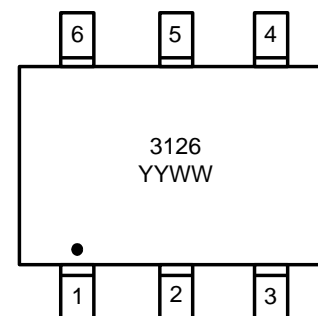

3126 = Device code
YY = Year code
WW = Week code
Marking

Features

- Input voltage range : 2.7~5.5V
- Continuous output current : 1.0A
- Switching frequency : 1MHz (Typ.)
- Efficiency : Up to 92%
- Main switch current limit : 2.75A (Min.)
- Output voltage accuracy : $\pm 2\%$

Applications

- MID
- Mobile power pack
- Mobile phones
- Notebook computers
- Portable games

Order information

Device	Package	Shipping
WD3126E-6/TR	SOT-23-6L	3000/Reel&Tape

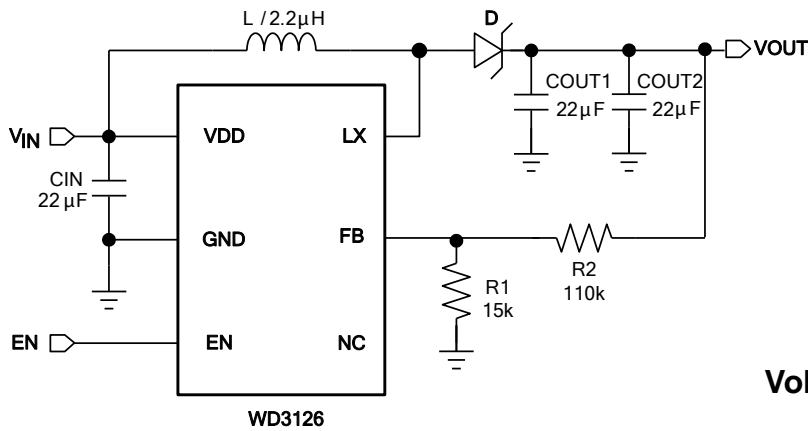
Typical applications

Pin descriptions

Symbol	SOT-23-6L	Descriptions
LX	1	Switch pin
GND	2	Ground
FB	3	Feedback Pin
EN	4	Enable, Active High
VDD	5	Power Supply
NC	6	Not connect

Voltage set

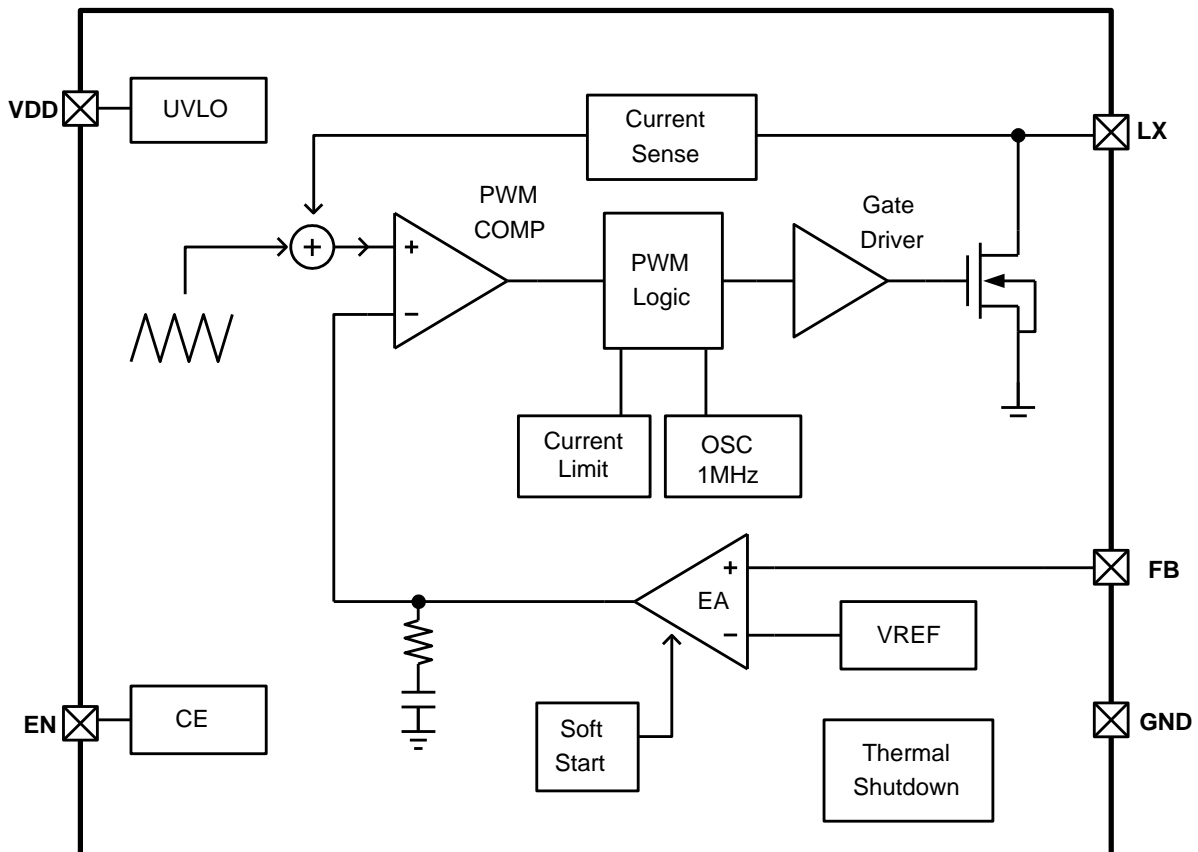
$$V_{OUT} = V_{FB} \times \left(1 + \frac{R2}{R1}\right)$$

Block diagram

Absolute maximum ratings

Parameter	Symbol	Value	Unit
VDD pin voltage range	V_{DD}	-0.3~6.5	V
EN pin voltage range	-	-0.3~ V_{DD}	V
LX pin voltage range (DC)	-	-0.3~6.5	V
Power Dissipation – SOT-23-6L (Note 1)	P_D	0.5	W
Power Dissipation – SOT-23-6L (Note 2)		0.3	W
Junction to Ambient Thermal Resistance – SOT-23-6L (Note 1)	$R_{\theta JA}$	250	°C/W
Junction to Ambient Thermal Resistance – SOT-23-6L (Note 2)		416	°C/W
Junction temperature	T_J	150	°C
Lead temperature(Soldering, 10s)	T_L	260	°C
Operation temperature	T_{opr}	-40 ~ 85	°C
Storage temperature	T_{stg}	-55 ~ 150	°C
ESD Ratings	HBM	8000	V
	MM	400	V

These are stress ratings only. Stresses exceeding the range specified under “Absolute Maximum Ratings” may cause substantial damage to the device. Functional operation of this device at other conditions beyond those listed in the specification is not implied and prolonged exposure to extreme conditions may affect device reliability.

Note 1: Surface mounted on FR-4 Board using 1 square inch pad size, dual side, 1oz copper

Note 2: Surface mounted on FR-4 board using minimum pad size, 1oz copper

Electrical Characteristics ($T_a=25^{\circ}\text{C}$, $V_{\text{IN}}=3.7\text{V}$, $V_{\text{EN}}=V_{\text{IN}}$, unless otherwise noted)

Parameter	Symbol	Test Condition	Min	Typ	Max	Units
Operation Voltage Range	V_{DD}		2.7	--	5.5	V
Under Voltage Lockout	V_{UVLO}	V_{IN} Rising	1.8	2.2	2.5	V
UVLO Hysteresis	$V_{\text{UVLO-HYS}}$			0.1		V
Quiescent Current	I_{Q}	$V_{\text{FB}} = 0.7\text{V}$		0.3	1	mA
Supply Current	I_{S}	Switching		1	2	mA
Shutdown Current	I_{SD}	$V_{\text{EN}} < 0.4\text{V}$			1	μA
Operation Frequency	f_{OSC}		0.8	1	1.2	MHz
Maximum Duty Cycle	D_{MAX}		85			%
FB Reference Voltage	V_{FB}	$I_{\text{LOAD}}=100\text{mA}$	0.588	0.6	0.612	V
Main Switch MOS on-resistance	$R_{\text{ON,S}}$	$I_{\text{LX}}=100\text{mA}$		130		m Ω
Main Switch Current Limit	I_{LIM}		2.75			A
Shutdown Voltage	V_{ENL}				0.4	V
Enable Voltage	V_{ENH}		1.5			V
EN Sink Current	I_{EN}			3		μA
Thermal Shutdown Temperature	T_{SD}			160		$^{\circ}\text{C}$
T_{SD} Hysteresis	$T_{\text{SD-HYS}}$			30		$^{\circ}\text{C}$

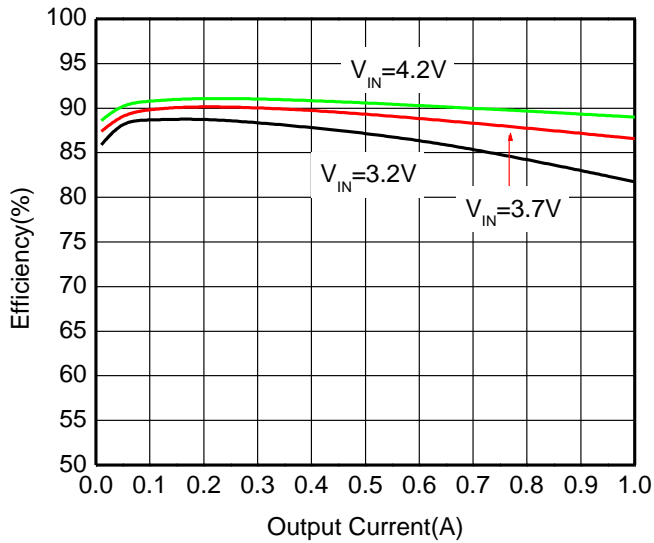
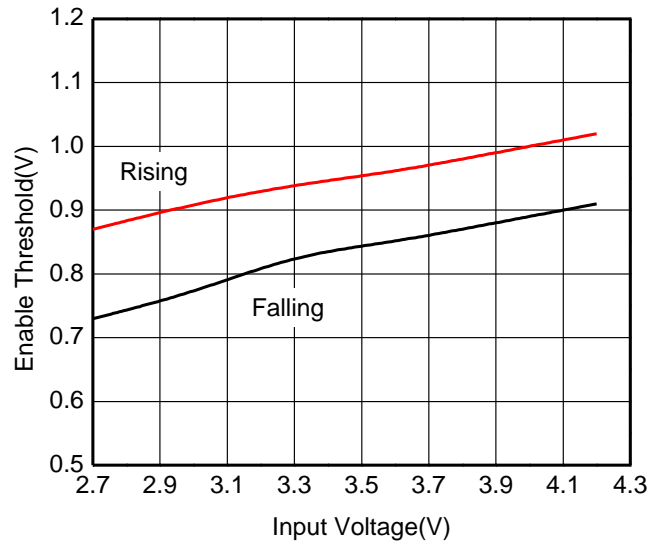
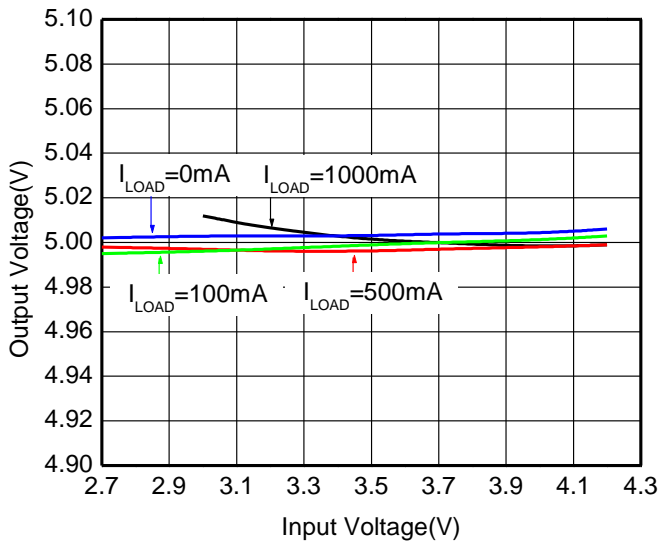
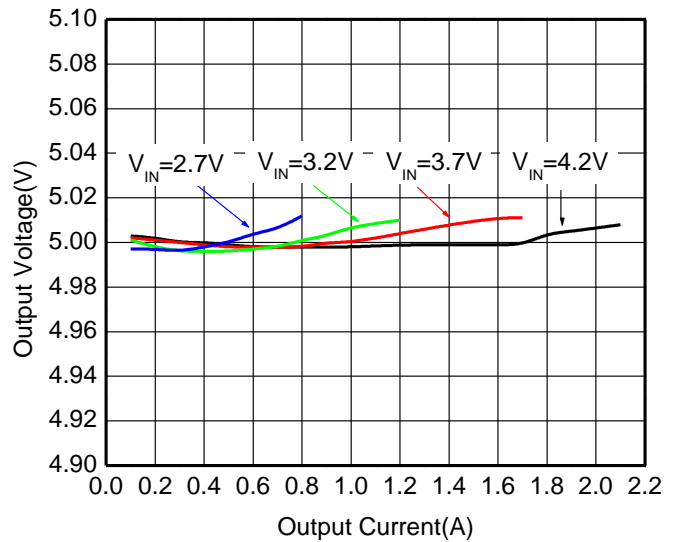
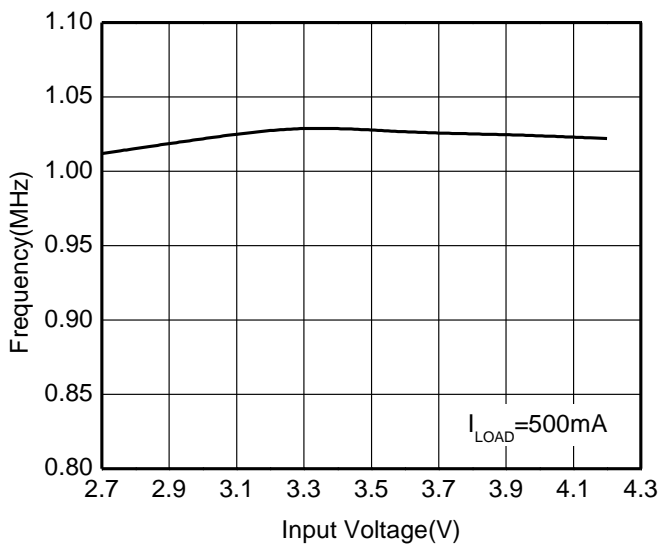
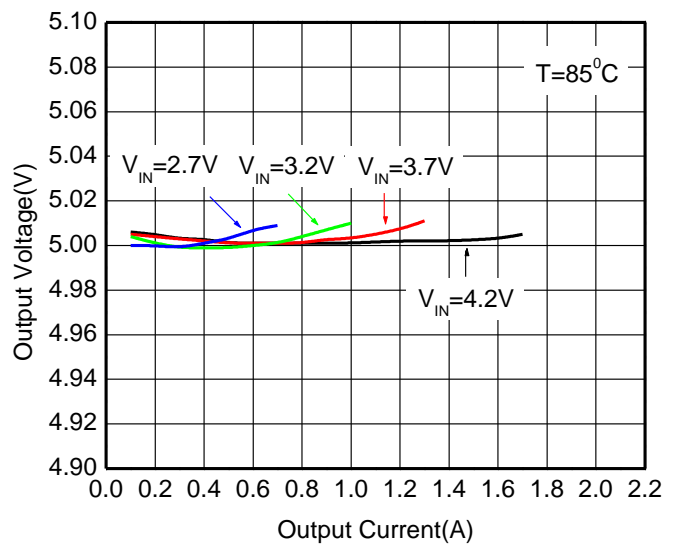
Typical Characteristics ($T_a=25^{\circ}\text{C}$, $V_{IN}=3.7\text{V}$, $V_{EN}=V_{IN}$, $R_1=15\text{K}\Omega$, $R_2=110\text{K}\Omega$ unless otherwise noted)

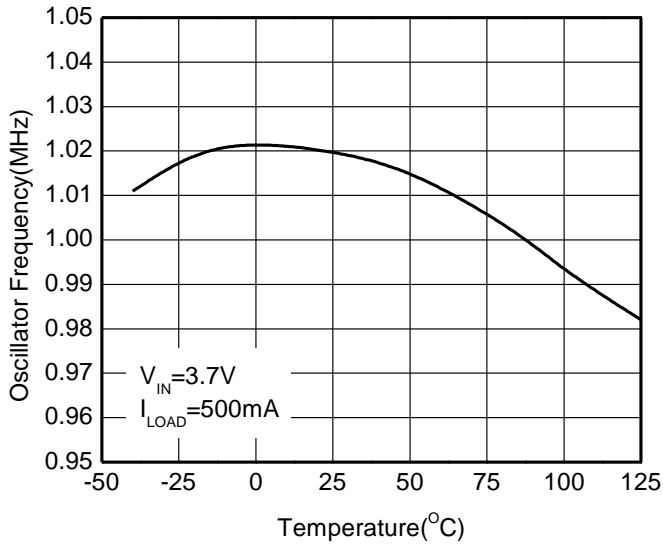
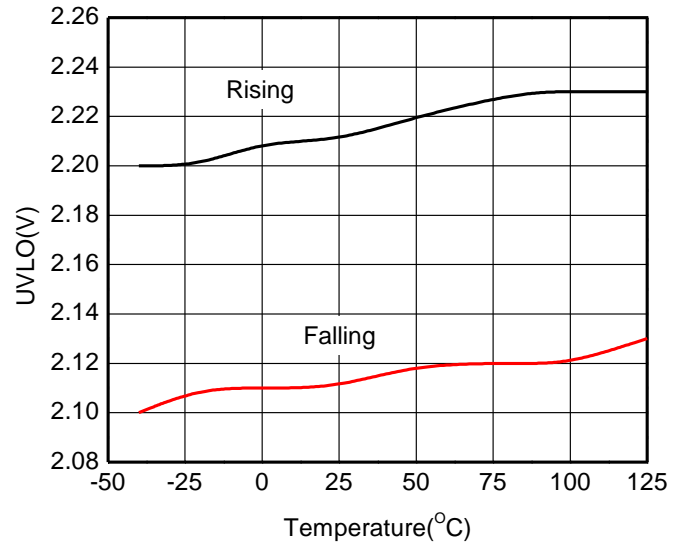
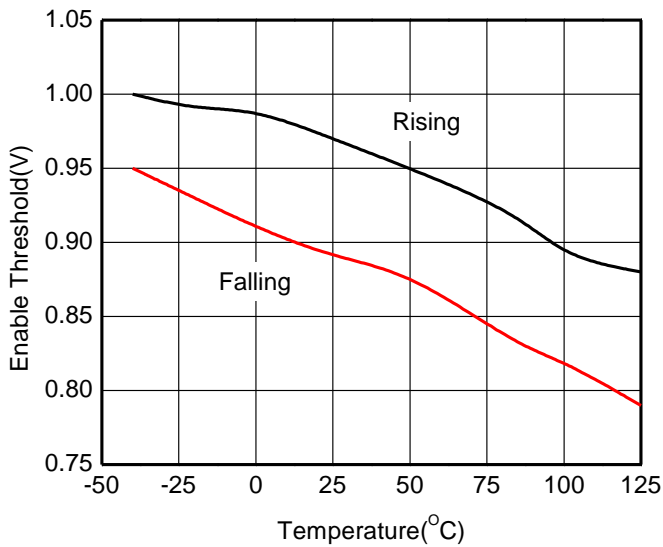
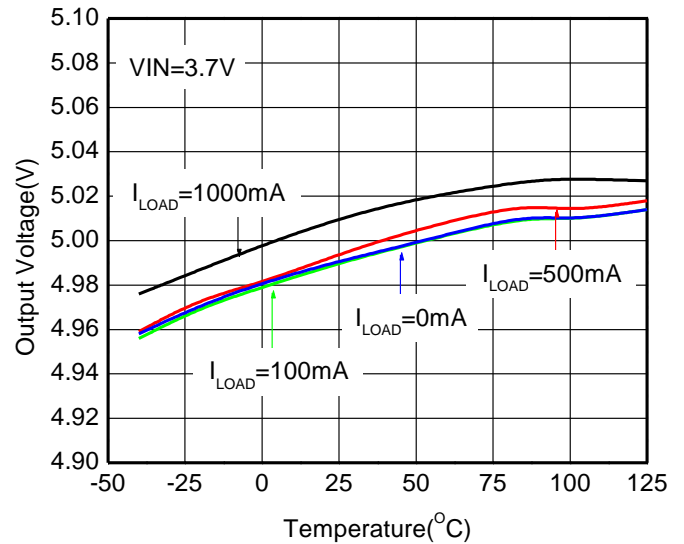
Efficiency vs. Output Current

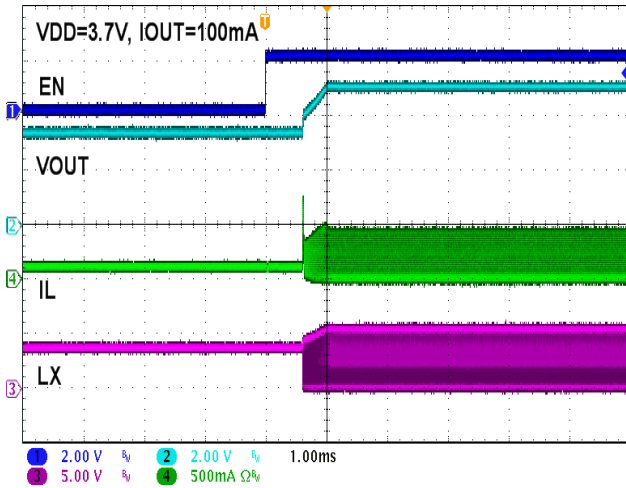
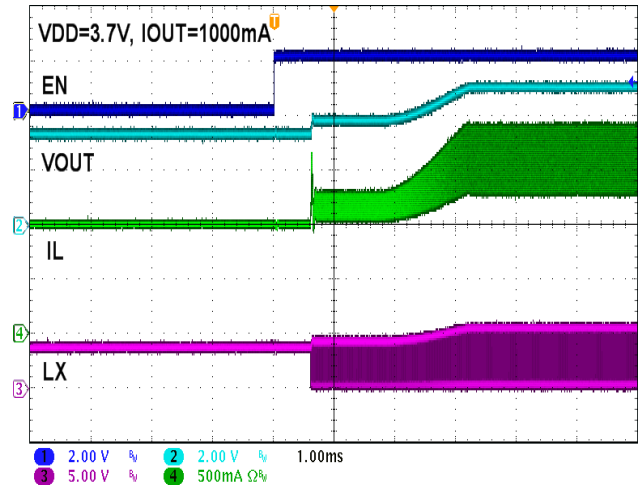
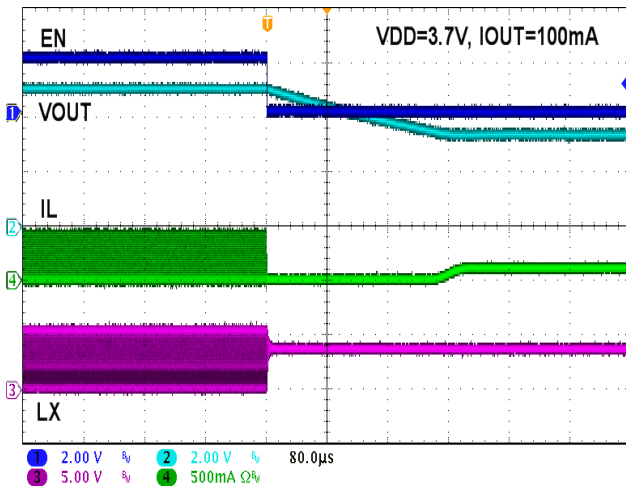
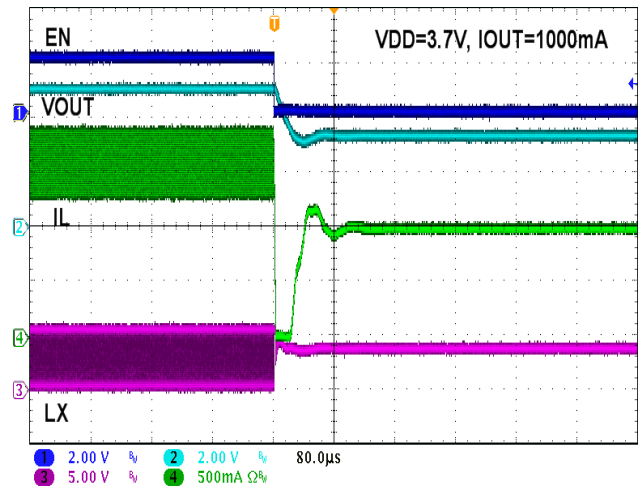
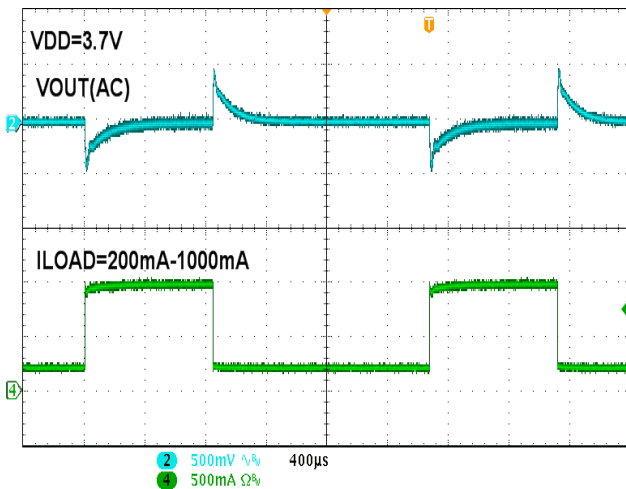
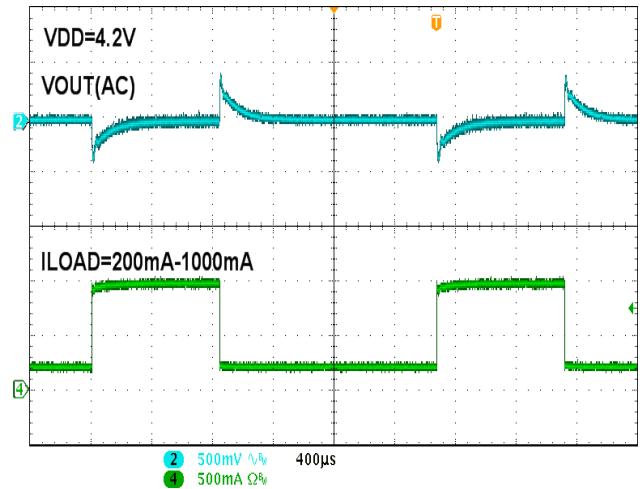
EN Threshold Voltage vs. Input Voltage

Output Voltage vs. Input Voltage

Output Voltage vs. Output Current

Frequency vs. Input Current

Output Voltage vs. Output Current

Oscillator Frequency vs. Temperature

UVLO vs. Temperature

Enable Threshold Voltage vs. Temperature

Output Voltage vs. Temperature

Start-up from EN

Start-up from EN

Shutdown from EN

Shutdown from EN

Load Step

Load Step

Operation Information

Normal Operation

The WD3126 is an adj. voltage output, peak current controlled DC-DC boost converter. This means that switch duty cycle is directly controlled by the peak switch current rather than only by output voltage.

The WD3126 regulates the output voltage using a combined pulse-width (PWM) and pulse-skipping (PSM) modulation topology. In PWM mode, the device runs at a 1MHz fixed frequency. Referring to the block diagram, the switch is turned ON at the start of each oscillator cycle. It is turned OFF when switch current reaches a predetermined level. The current trip level is set by using an error amplifier which senses the converter output voltage. The main switch current sensing voltage signal is summed by a slope compensation voltage signal. Slope compensation is necessary to prevent sub-harmonic oscillations that may occur in peak current mode architectures when exceeding 50% duty cycle. At very light loads, the WD3126 will automatically enter pulse skipping mode (PSM). When the converter feedback output voltage is slightly higher than 0.6V, the device will stop switching and skip some periods to maintain output regulation.

The WD3126 is highly integrated with a low on-resistance N-MOS switch, internal control-loop compensation network and soft-start circuitry. Additional features include Cycle-By-Cycle Current Limit Protection, Under Voltage Protection and Over Temperature Protection.

Start-Up

The build-in soft-start function of WD3126 is implemented to suppress the inrush current to an acceptable value at the beginning of power on.

Cycle by Cycle Current Limit

The WD3126 uses a cycle-by-cycle current limit circuitry to limit the inductor peak current in the event of an overload condition. The current flow

through inductor in charging phase is detected by a current sensing circuit. As the value comes across the current limiting threshold the N- MOSFET turns off, so that the inductor will be forced to leave charging stage and enter discharging stage. Therefore, the inductor current will not increase over the current limiting threshold.

UVLO Protection

To avoid malfunction of the WD3126 at low input voltages, an under voltage lockout is included that disables the device, until the input voltage exceeds 2.2V (Typ.).

Shutdown Mode

Drive EN to GND to place the WD3126 in shutdown mode. In shutdown mode, the reference, control circuit, and the main switch turn off. Input current falls to smaller than 1 μ A during shutdown mode.

Over Temperature Protection (OTP)

As soon as the junction temperature (T_J) exceeds 160°C (Typ.), the WD310 goes into thermal shutdown. In this mode, the main N-MOSFET is turned off until temperature falls below typically 130°C. Then the device starts switching again.

Application Information

External component selection for the application circuit depends on the load current requirements. Certain tradeoffs between different performance parameters can also be made.

Boost Inductor Selection

A 2.2uH inductor is recommended to connect from VDD to LX. The minimum and maximum inductor values are constrained by many considerations. The minimum inductance is limited by the peak inductor-current value. The ripple current in the inductor is inversely proportional to the inductance value, so the output voltage may fall out of regulation if the peak inductor current exceeds the current-limit value (2.75A minimum). Using a nominal 2.2uH inductor allows full recommended current operation even if the inductance is 20% low (1.76 uH) due to component variation. A maximum 4.7uH (typical) inductor value is recommended to maintain adequate phase margin over the full range of recommended operating conditions.

The saturation current of inductor should be higher enough than the peak switch current. And the inductor should have low core losses at 1MHz and low DCR (copper wire resistance).

Input Capacitor Selection

Connect the input capacitance from VDD to the reference ground plane. Input capacitance reduces the ac voltage ripple on the input rail by providing a low-impedance path for the switching current of the boost converter. The WD3126 does not have a minimum or maximum input capacitance requirement for operation, but a 10uF to 22uF, X7R or X5R ceramic capacitor is recommended for most applications for reasonable input-voltage ripple performance. There are several scenarios where it is recommended to use additional input capacitance.

Output Capacitor Selection

Connect the boost-converter output capacitance from Output to the reference ground plane. The Output capacitance controls the ripple voltage on the Output rail and provides a low-impedance path for the switching and transient-load currents of the boost converter. It also sets the location of the output pole in the control loop of the boost converter. There are limitations to the minimum and maximum capacitance on Output. The recommended Output Capacitors are two 22μF, no less than two 10μF, X5R or X7R ceramic capacitor, for most applications. The recommended minimum capacitors on Output are two 22uF, X5R or X7R ceramic capacitor. The low ESR of the ceramic capacitor minimizes ripple voltage and power dissipation from the large, pulsating currents of the boost converter and provides adequate phase margin across all recommended operating conditions.

Diode Selection

The rectifier diode supplies current path to the inductor when the internal MOSFET is off. Use a schottky diode with low forward voltage to reduce losses. The diode should be rated for a reverse blocking voltage greater than the output voltage used. The average current rating must be greater than the maximum load current expected, and the peak current rating must be greater than the peak inductor current.

Diode the following requirements:

- Low forward voltage
- High switching speed : 50ns max.
- Reverse voltage : $V_{OUT} + V_F$ or more
- Rated current : I_{PK} or more

PC Board Layout Considerations

A good circuit board layout aids in extracting the most performance from the WD3126. Poor circuit layout degrades the output ripple and the electromagnetic interference (EMI) or electromagnetic compatibility (EMC) performance. The evaluation board layout is optimized for the WD3126. Use this layout for best performance. If this layout needs changing, use the following guidelines:

1. Use separate analog and power ground planes. Connect the sensitive analog circuitry (such as voltage divider components) to analog ground; connect the power components (such as input and output bypass capacitors) to power ground. Connect the two ground planes together near the load to reduce the effects of voltage dropped on circuit board traces. Locate C_{IN} as close to the V_{DD} pin as possible, and use separate input bypass capacitors for the analog.
2. Route the high current path from C_{IN} , through L to the LX and PGND pins as short as possible.
3. Keep high current traces as short and as wide as possible.
4. The output filter of the boost converter is also critical for layout. The Diode and Output capacitors should be placed to minimize the area of current loop through Output –PGND–LX.
5. Avoid routing high impedance traces, such as Output, near the high current traces and components or near the Diode node (D).
6. If high impedance traces are routed near high current and/or the LX node, place a ground plane shield between the traces.

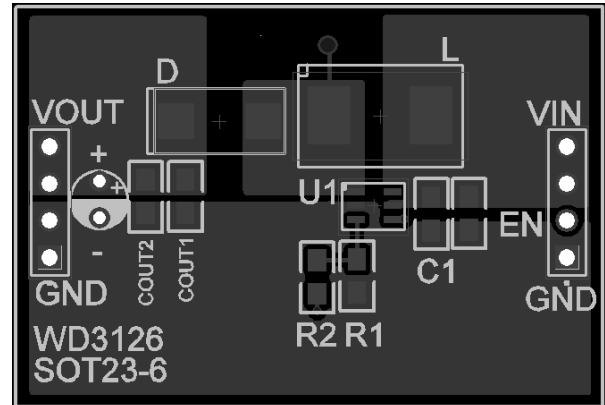

WD3126 Demo Board Layout (Top)

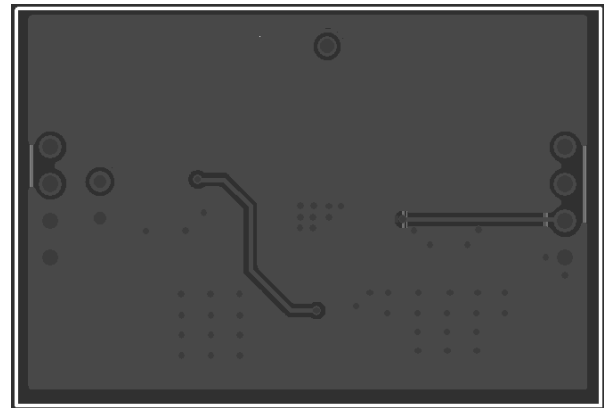

WD3126 Demo Board Layout (Bottom)

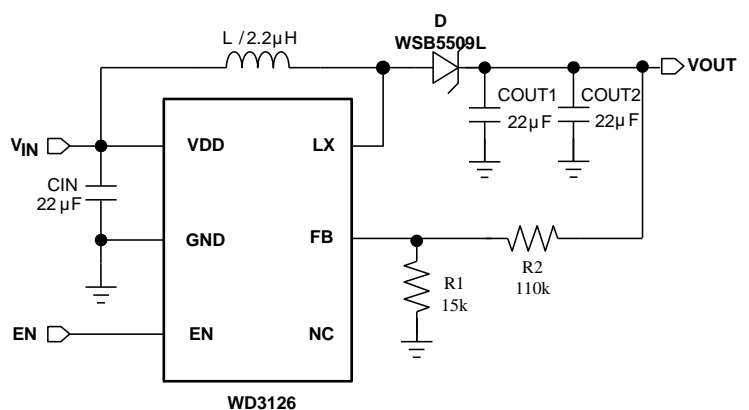

WD3126 Demo Board Schematic

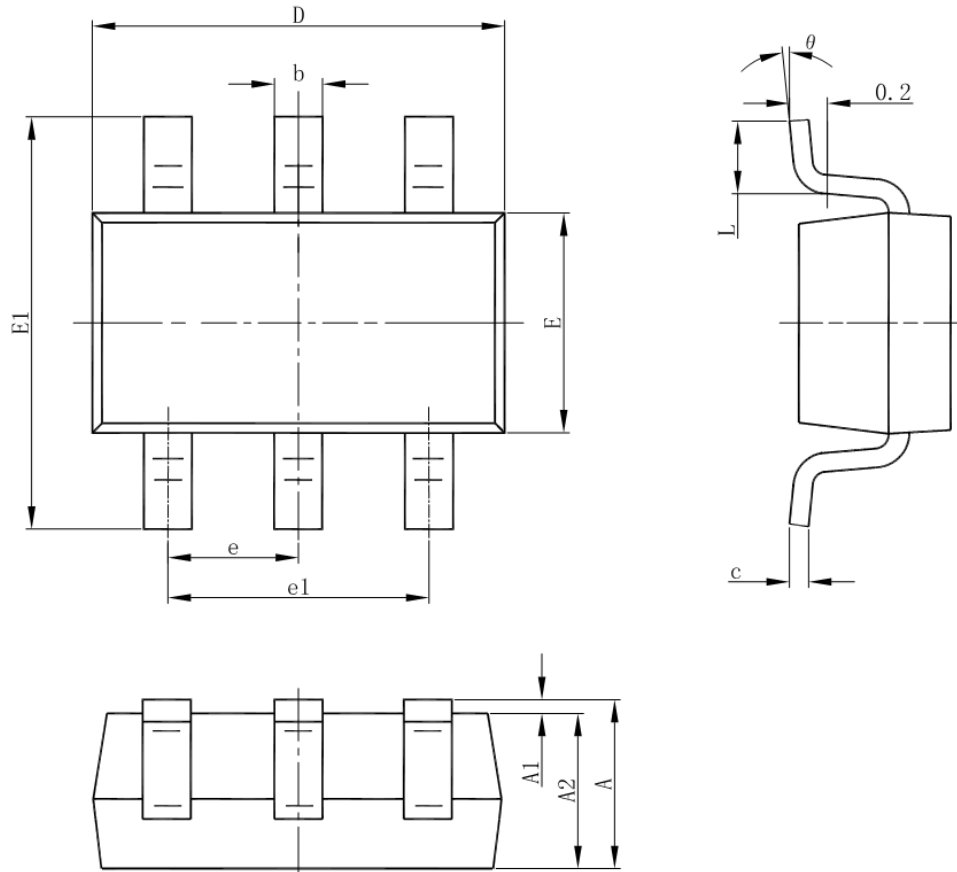
Package outline dimensions
SOT-23-6L

Symbol	Dimensions in millimeter		
	Min.	Typ.	Max.
A	1.050	-	1.250
A1	0.000	-	0.100
A2	1.050	-	1.150
b	0.300	-	0.500
c	0.100	-	0.200
D	2.820	2.900	3.020
E	1.500	1.600	1.700
E1	2.650	2.800	2.950
e	0.950(BSC)		
e1	1.800	-	2.000
L	0.300	-	0.600
theta	0°	-	8°