

WPT2N31

Single, PNP, -30V, -3A, Power Transistor with 20V N-MOSFET

[Http://www.willsemi.com](http://www.willsemi.com)

Descriptions

The WPT2N31 is PNP bipolar power transistor with 20V N-MOSFET. This device is suitable for use in charging circuit and other power management. Standard Product WPT2N31 is Pb-free.

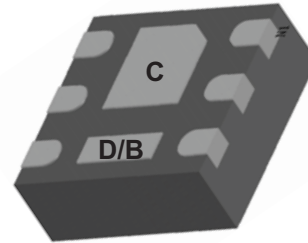

DFN2x2-6L

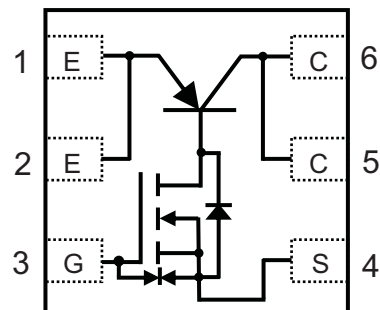

Pin configuration (Top view)

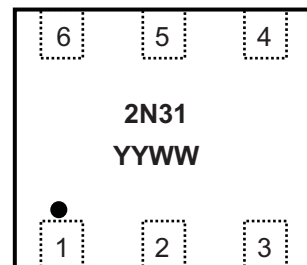

2N31 = Device code
 YY = Year
 WW = Week
Marking

Features

- Ultra low collector-to-emitter saturation voltage
- High DC current gain >100
- 3A continue collector current
- Small package DFN2x2-6L

Applications

- Charging circuit
- Other power management in portable equipments

Order information

Device	Package	Shipping
WPT2N31-6/TR	DFN2x2-6L	3000/Reel&Tape

Absolute maximum ratings

Parameter	Symbol	Value	Unit
PNP Transistor			
Collector-emitter voltage	V_{CEO}	-30	V
Collector-base voltage	V_{CBO}	-30	V
Emitter-base voltage	V_{EBO}	-6	V
Continues collector current ^a	I_C	-3	A
Continues collector current ^b		-2	A
Pulse collector current ^c	I_{CM}	-6	A
N-MOSFET			
Drain-Source Voltage	V_{DS}	20	V
Gate-Source Voltage	V_{GS}	± 6	V
Continuous Drain Current ^a	I_D	0.80	A
Continuous Drain Current ^b		0.69	A
Pulsed Drain Current ^c	I_{DM}	1.4	A
Power Dissipation and temperature			
Power dissipation ^a	P_D	1.2	W
Power dissipation ^b		0.8	W
Junction Temperature	T_J	150	$^{\circ}C$
Lead Temperature	T_L	260	$^{\circ}C$
Operation Temperature	T_A	-40 ~ 85	$^{\circ}C$
Storage Temperature Range	T_{stg}	-55 to 150	$^{\circ}C$

Thermal resistance ratings

Parameter	Symbol	Value	Unit
Junction-to-Ambient Thermal Resistance ^a	$R_{\theta JA}$	104	$^{\circ}C/W$
Junction-to-Ambient Thermal Resistance ^b	$R_{\theta JA}$	155	$^{\circ}C/W$

a Surface mounted on FR-4 Board using 1 square inch pad size, 1oz copper

b Surface mounted on FR-4 board using minimum pad size, 1oz copper

c Pulse width=300 μ s, Duty Cycle<2%

d Maximum junction temperature $T_J=150^{\circ}C$.

Electronics Characteristics (Ta=25°C, unless otherwise noted)

Parameter	Symbol	Test Conditions	Min.	Typ.	Max.	Unit
PNP Transistor						
Collector-emitter breakdown voltage	BV_{CEO}	$I_C=-10mA, I_B=0mA$	-30			V
Collector-base breakdown voltage	BV_{CBO}	$I_C=-1mA, I_E=0mA$	-30			V
Emitter-base breakdown voltage	BV_{EBO}	$I_E=-100\mu A, I_C=0mA$	-6			V
Collector cutoff current	I_{CBO}	$V_{CB}=-30V$			-100	nA
Emitter cutoff current	I_{EBO}	$V_{EB}=-5V$			-100	nA
Collector-emitter saturation voltage	$V_{CE(sat)}$	$I_C=-2A, I_B=-200mA$		-0.2	-0.4	V
Base-emitter saturation voltage	$V_{BE(sat)}$	$I_C=-2A, I_B=-200mA$		-1.0	-1.5	V
Base-emitter forward voltage	$V_{BE(on)}$	$I_C=-0.5A, V_{CE}=-2V$		-0.7	-1.0	V
DC current gain	h_{FE}	$V_{CE}=-2V, I_C=-1A$	100		300	
N-MOSFET						
Drain-Source Breakdown Voltage	$V_{(BR)DSS}$	$V_{GS}=0V, I_D=250\mu A$	20			V
Zero Gate Voltage Drain Current	I_{DSS}	$V_{DS}=20V, V_{GS}=0V$			1	μA
Gate –Source leakage current	I_{GSS}	$V_{DS}=0V, V_{GS}=\pm 5V$			± 5	μA
Gate Threshold Voltage	$V_{GS(th)}$	$V_{DS}=V_{GS}, I_D=250\mu A$	0.45	0.55	1.0	V
Drain-Source On-Resistance	$R_{DS(on)}$	$V_{GS}=4.5V, I_D=0.55A$		220	260	m Ω
		$V_{GS}=2.5V, I_D=0.45A$		260	310	m Ω
		$V_{GS}=1.8V, I_D=0.35A$		320	380	m Ω
		$V_{GS}=1.5V, I_D=0.10A$		600	1100	m Ω
Input Capacitance	C_{iss}	$V_{DS}=10V,$		50		pF
Output Capacitance	C_{oss}	$V_{GS}=0V,$		13		pF
Reverse Transfer Capacitance	C_{rss}	$F=1Mhz$		8		pF
Total Gate Charge	$Q_{G(TOT)}$	$V_{DS}=10V,$ $V_{GS}=4.5V,$ $I_D=0.6A$		1.15		nC
Threshold gate charge	$Q_{G(TH)}$			0.06		nC
Gate-Source Charge	Q_{GS}			0.15		nC
Gate-Drain Charge	Q_{GD}			0.23		nC
Turn-On Delay Time	$t_{d(on)}$		$V_{DD}=10V, V_{GS}=4.5V,$ $I_D=0.5A,$ $R_L=10\Omega, R_G=6\Omega$		22	
Turn-On Rise Time	t_r			80		ns
Turn-Off Delay Time	$t_{d(off)}$			700		ns
Turn-Off Fall Time	t_f			650		ns
Body Diode Forward Voltage	V_{SD}	$V_{GS}=0V, I_S=0.35A$	0.5	0.7	1.0	V

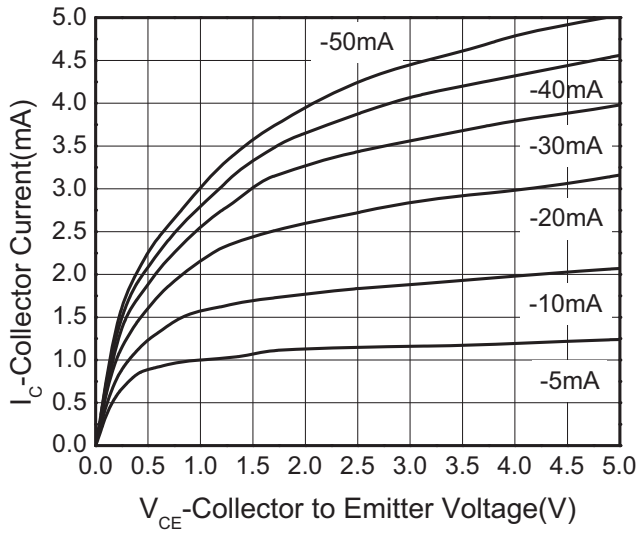
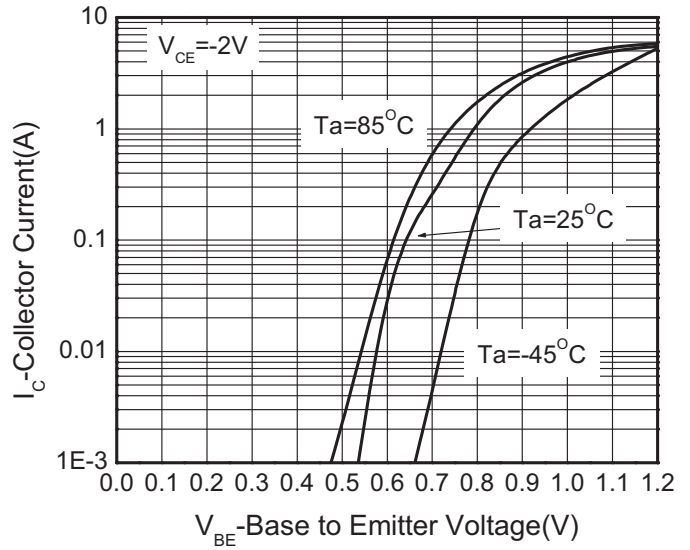
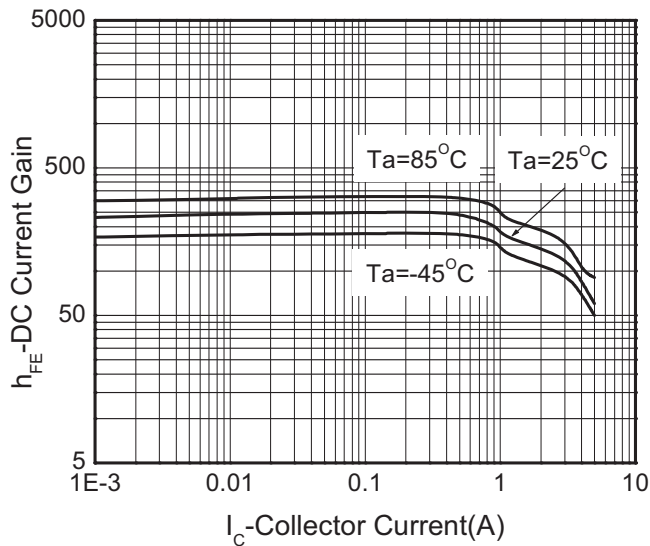
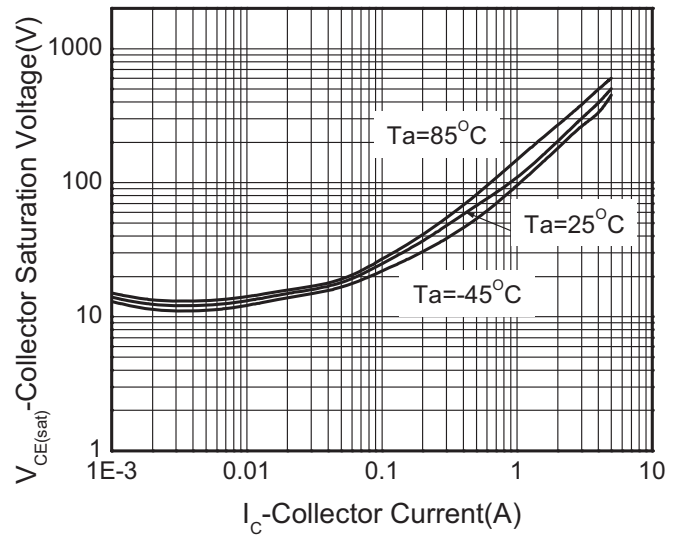
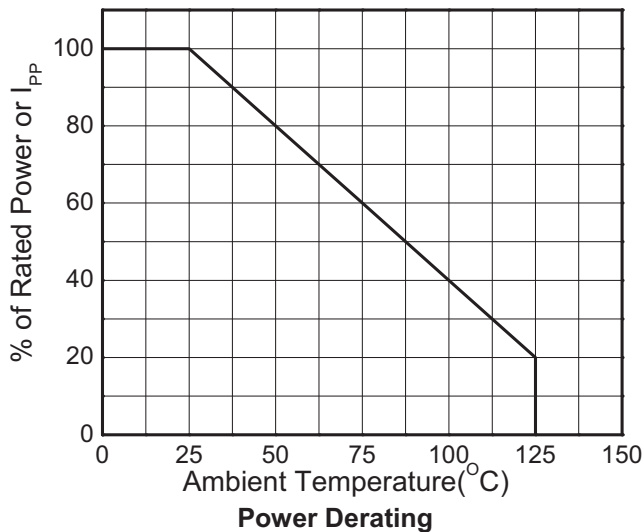
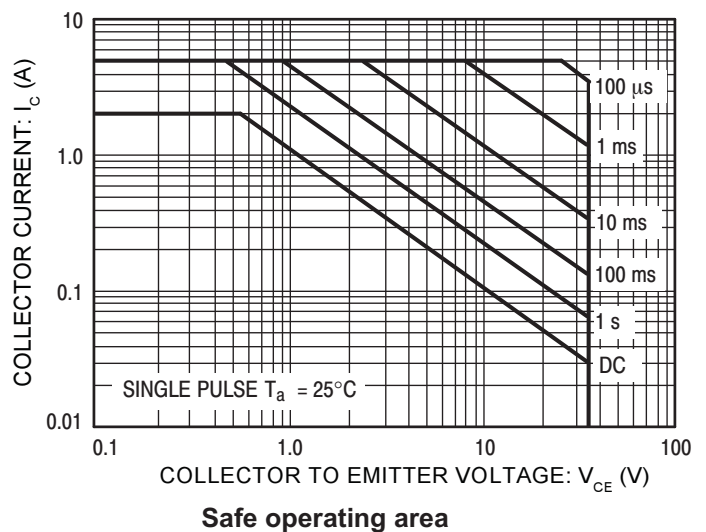
Typical Characteristics (Ta=25°C, unless otherwise noted)
PNP Transistor

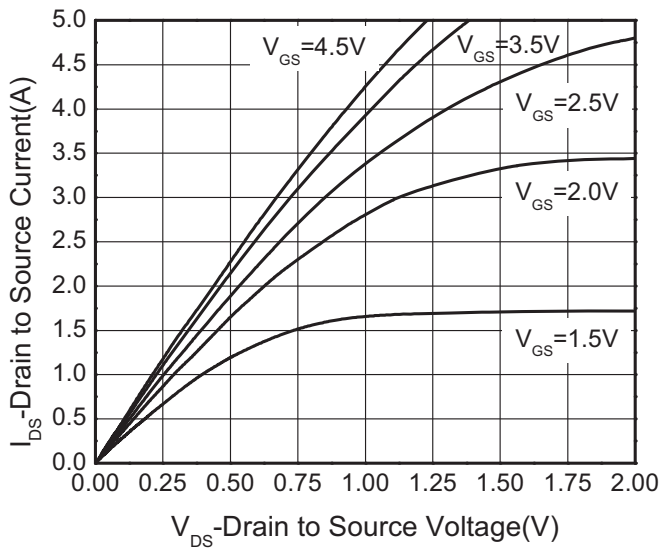
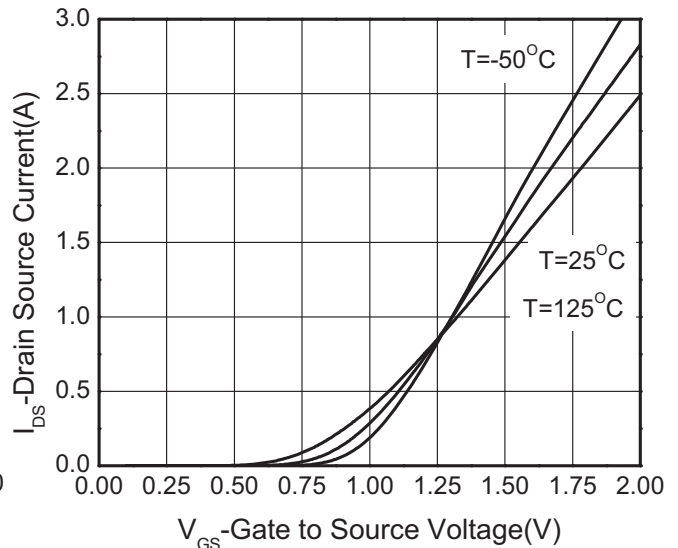
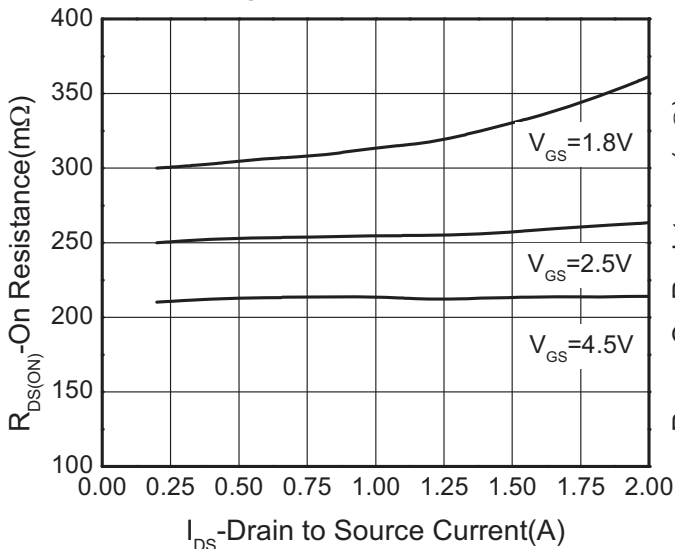
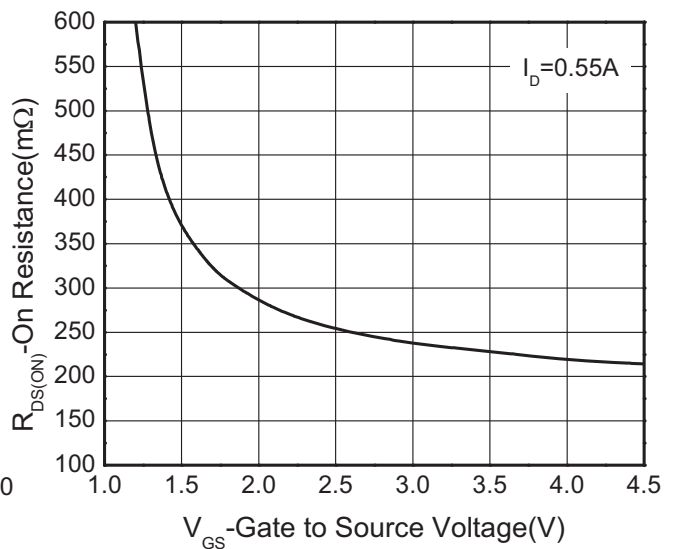
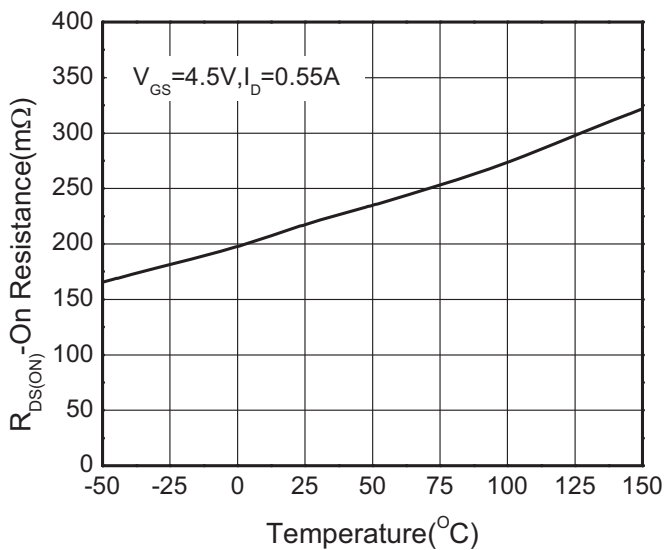
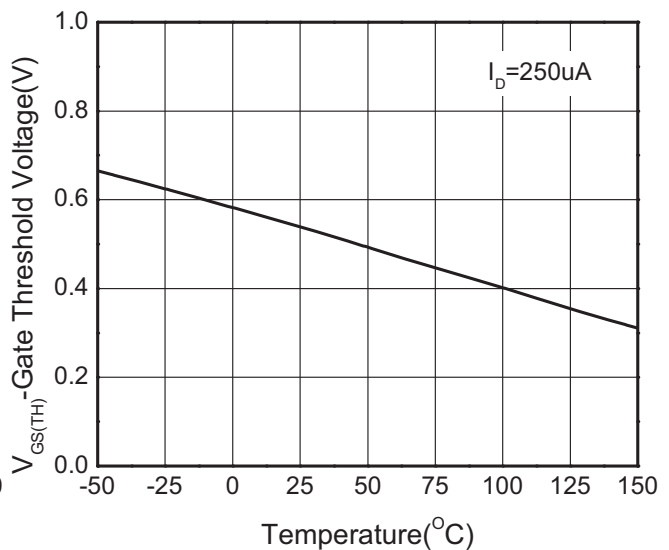
Output characteristics

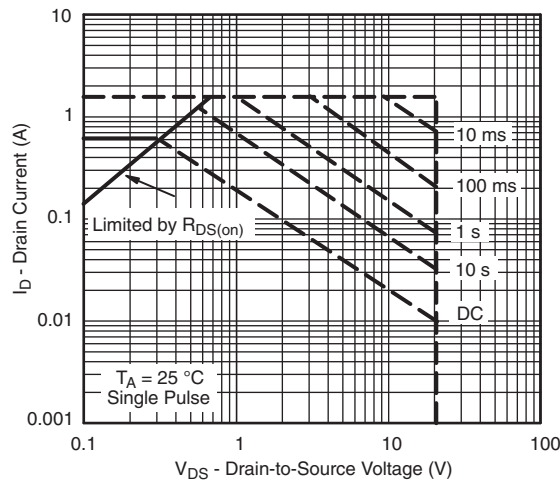
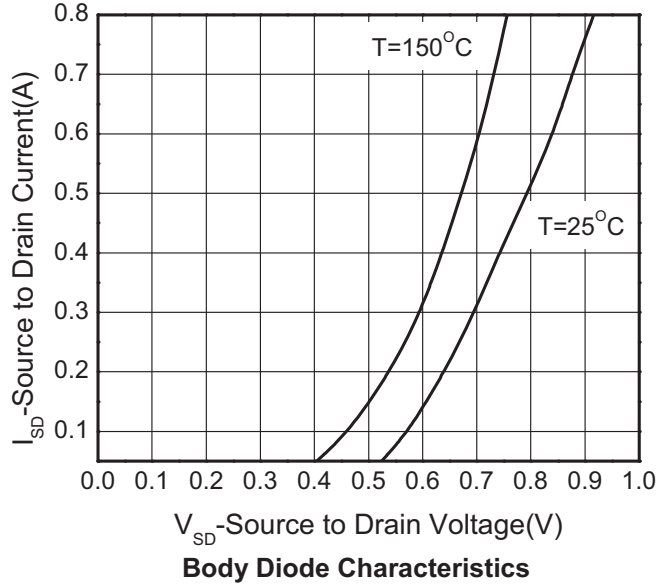
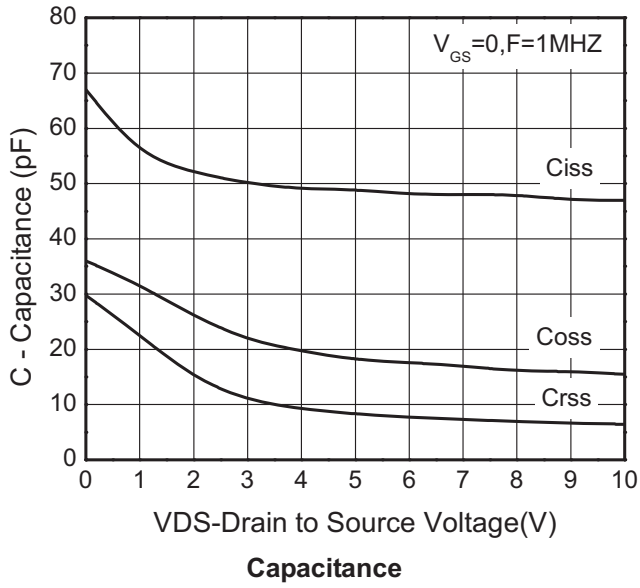
Transfer characteristics

DC current gain

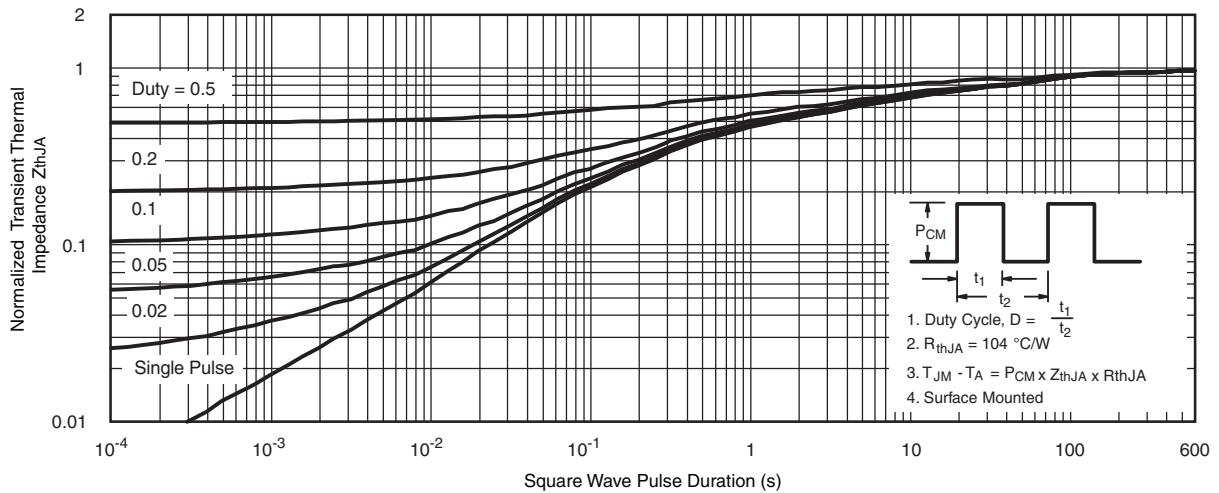
C-E saturation voltage vs. Collector current

Power Derating

Safe operating area

N-MOSFET

Output Characteristics

Transfer Characteristics

ON Resistance vs. Drain Current

ON Resistance vs. Gate-to-Source Voltage

ON Resistance vs. Junction Temperature

Threshold Voltage vs. Temperature



Safe Operation Area



Transient thermal response (Junction-to-Ambient)

Application note and recommend layout

1. The greater exposed pad of bottom is connected to collector of transistor internally.
2. The smaller exposed pad of bottom is connected to drain of MOSFET and base of transistor internally.
3. Recommend layout as below:

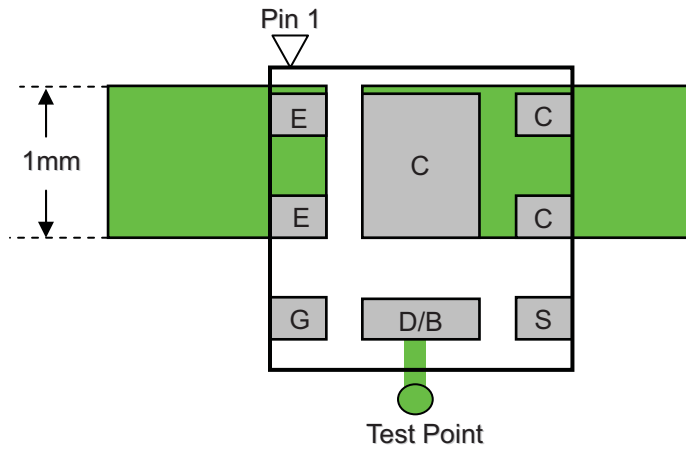

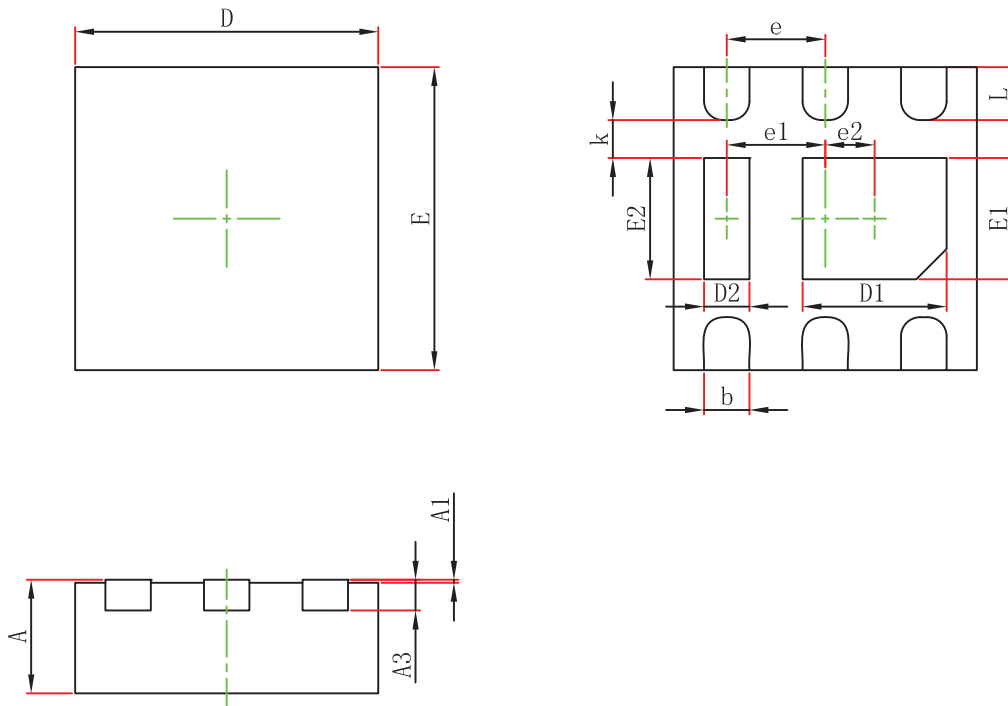
Package outline dimensions
DFN2x2-6L

Symbol	Dimensions In Millimeters		
	Min.	Typ.	Max.
A	0.700		0.800
A1	0.000		0.050
A3	0.203 Ref.		
D	1.924	2.000	2.076
E	1.924	2.000	2.076
D1	0.850	0.950	1.050
E1	0.700	0.800	0.900
D2	0.200	0.300	0.400
E2	0.700	0.800	0.900
e1	0.650 Typ.		
e2	0.325 Typ.		
k	0.200 Min.		
b	0.250	0.300	0.350
e	0.650 Typ.		
L	0.300	0.350	0.400