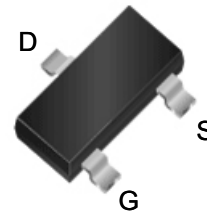
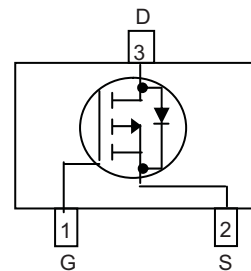

**WPM2083**
**Single P-Channel, -20V, -2.4A, Power MOSFET**
[Http://www.sh-willsemi.com](http://www.sh-willsemi.com)

$V_{DS}$ (V)	Typical $R_{DS(on)}$ (m $\Omega$ )
-20	81 @ $V_{GS}=-4.5V$
	110 @ $V_{GS}=-2.5V$

**SOT-23**

**Pin configuration (Top view)**
**Descriptions**

The WPM2083 is P-Channel enhancement MOS Field Effect Transistor. Uses advanced trench technology and design to provide excellent  $R_{DS(ON)}$  with low gate charge. This device is suitable for use in DC-DC conversion, power switch and charging circuit. Standard Product WPM2083 is Pb-free.

**Features**

- Trench Technology
- Supper high density cell design
- Excellent ON resistance
- Extremely Low Threshold Voltage
- Small package SOT-23

**Applications**

- DC/DC converters
- Power supply converters circuit
- Load/Power Switching for portable device

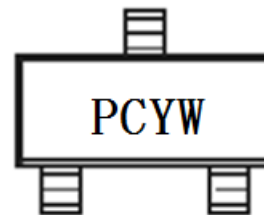

PC = Device Code  
 Y = Year  
 W = Week(A~z)

**Marking**
**Order information**

Device	Package	Shipping
WPM2083-3/TR	SOT-23	3000/Tape&Reel

**Absolute Maximum ratings**

Parameter	Symbol	10 s	Steady State	Unit	
Drain-Source Voltage	$V_{DS}$	-20		V	
Gate-Source Voltage	$V_{GS}$	±8			
Continuous Drain Current <sup>a d</sup>	$I_D$	$T_A=25^{\circ}C$	-2.4	-2.2	A
		$T_A=70^{\circ}C$	-1.9	-1.8	
Maximum Power Dissipation <sup>a d</sup>	$P_D$	$T_A=25^{\circ}C$	0.9	0.8	W
		$T_A=70^{\circ}C$	0.6	0.5	
Continuous Drain Current <sup>b d</sup>	$I_D$	$T_A=25^{\circ}C$	-2.2	-2.0	A
		$T_A=70^{\circ}C$	-1.7	-1.6	
Maximum Power Dissipation <sup>b d</sup>	$P_D$	$T_A=25^{\circ}C$	0.8	0.6	W
		$T_A=70^{\circ}C$	0.5	0.4	
Pulsed Drain Current <sup>c</sup>	$I_{DM}$	-10		A	
Operating Junction Temperature	$T_J$	-55 to 150		°C	
Lead Temperature	$T_L$	260		°C	
Storage Temperature Range	$T_{stg}$	-55 to 150		°C	

**Thermal resistance ratings**

Single Operation					
Parameter		Symbol	Typical	Maximum	Unit
Junction-to-Ambient Thermal Resistance <sup>a</sup>	$t \leq 10$ s	$R_{\theta JA}$	105	135	°C/W
	Steady State		120	155	
Junction-to-Ambient Thermal Resistance <sup>b</sup>	$t \leq 10$ s	$R_{\theta JA}$	130	160	
	Steady State		145	190	
Junction-to-Case Thermal Resistance	Steady State	$R_{\theta JC}$	60	75	

a Surface mounted on FR4 Board using 1 square inch pad size, 1oz copper

b Surface mounted on FR4 board using minimum pad size, 1oz copper

c Repetitive rating, pulse width limited by junction temperature,  $t_p=10\mu s$ , Duty Cycle=1%

d Repetitive rating, pulse width limited by junction temperature  $T_J=150^{\circ}C$ .

**Electronics Characteristics (Ta=25°C, unless otherwise noted)**

Parameter	Symbol	Test Conditions	Min	Typ	Max	Unit
<b>OFF CHARACTERISTICS</b>						
Drain-to-Source Breakdown Voltage	$BV_{DSS}$	$V_{GS} = 0\text{ V}, I_D = -250\mu\text{A}$	-20			V
Zero Gate Voltage Drain Current	$I_{DSS}$	$V_{DS} = -16\text{ V}, V_{GS} = 0\text{ V}$			-1	$\mu\text{A}$
Gate-to-source Leakage Current	$I_{GSS}$	$V_{DS} = 0\text{ V}, V_{GS} = \pm 8\text{ V}$			$\pm 100$	nA
<b>ON CHARACTERISTICS</b>						
Gate Threshold Voltage	$V_{GS(TH)}$	$V_{GS} = V_{DS}, I_D = -250\mu\text{A}$	-0.4	-0.65	-1	V
Drain-to-source On-resistance	$R_{DS(on)}$	$V_{GS} = -4.5\text{ V}, I_D = -2.4\text{ A}$		81	110	m $\Omega$
		$V_{GS} = -2.5\text{ V}, I_D = -2.0\text{ A}$		103	150	
<b>CHARGES, CAPACITANCES AND GATE RESISTANCE</b>						
Input Capacitance	$C_{ISS}$	$V_{GS} = 0\text{ V}, f = 1.0\text{ MHz}, V_{DS} = -10\text{ V}$		444		pF
Output Capacitance	$C_{OSS}$			52		
Reverse Transfer Capacitance	$C_{RSS}$			41		
Total Gate Charge	$Q_{G(TOT)}$	$V_{GS} = -4.5\text{ V}, V_{DS} = -10\text{ V}, I_D = -2.4\text{ A}$		5.8		nC
Threshold Gate Charge	$Q_{G(TH)}$			0.5		
Gate-to-Source Charge	$Q_{GS}$			0.7		
Gate-to-Drain Charge	$Q_{GD}$			1.6		
<b>SWITCHING CHARACTERISTICS</b>						
Turn-On Delay Time	$t_d(ON)$	$V_{GS} = -4.5\text{ V}, V_{DS} = -6\text{ V}, I_D = -1\text{ A}, R_G = 6\Omega$		9.8		ns
Rise Time	$t_r$			4.4		
Turn-Off Delay Time	$t_d(OFF)$			35		
Fall Time	$t_f$			7.4		
<b>BODY DIODE CHARACTERISTICS</b>						
Forward Voltage	$V_{SD}$	$V_{GS} = 0\text{ V}, I_S = -2.4\text{ A}$		-0.8	-1.5	V

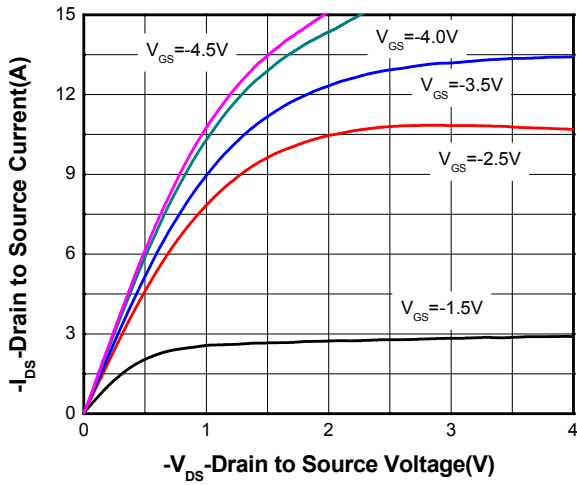
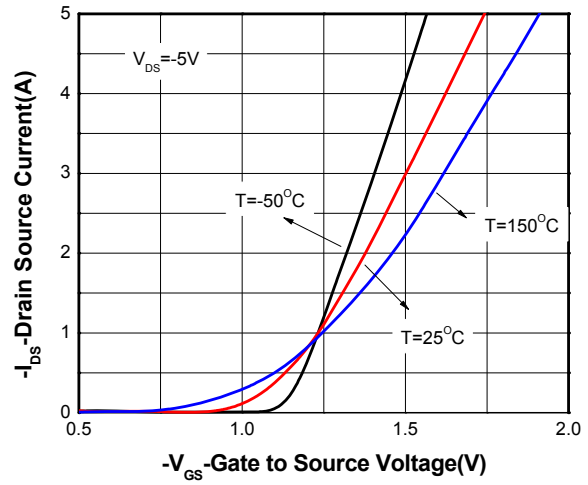
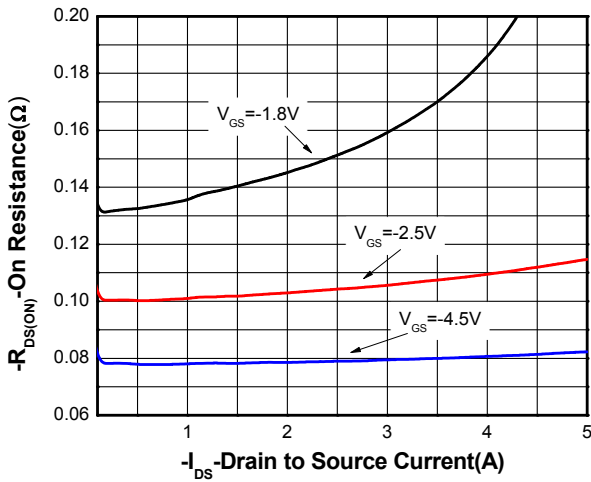
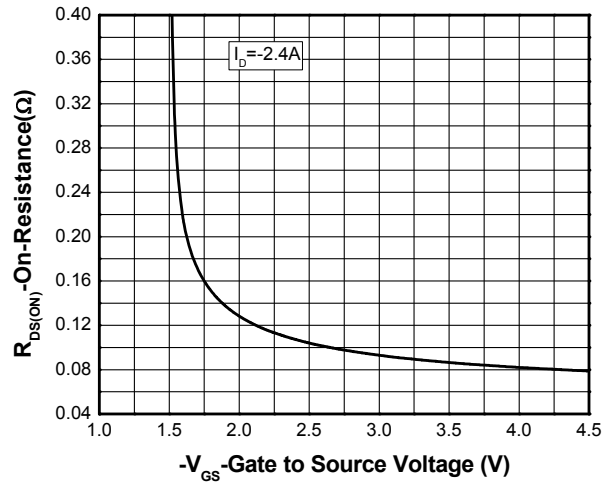
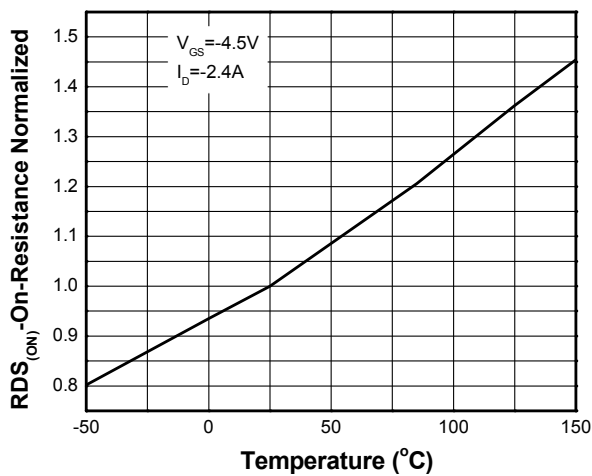
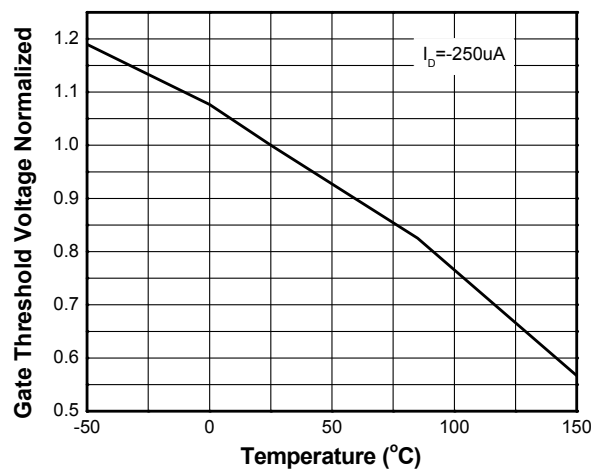
**Typical Characteristics (Ta=25°C, unless otherwise noted)**

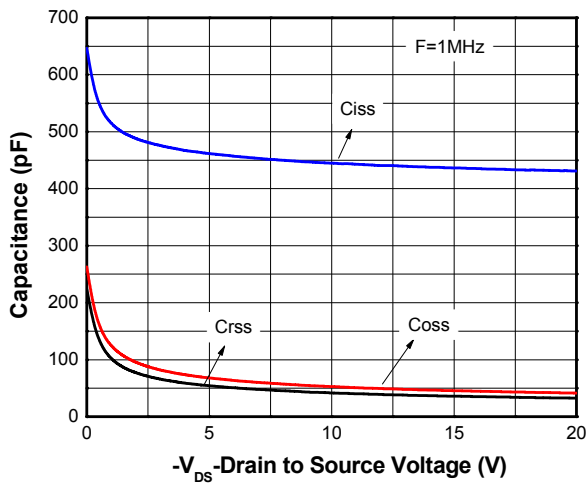
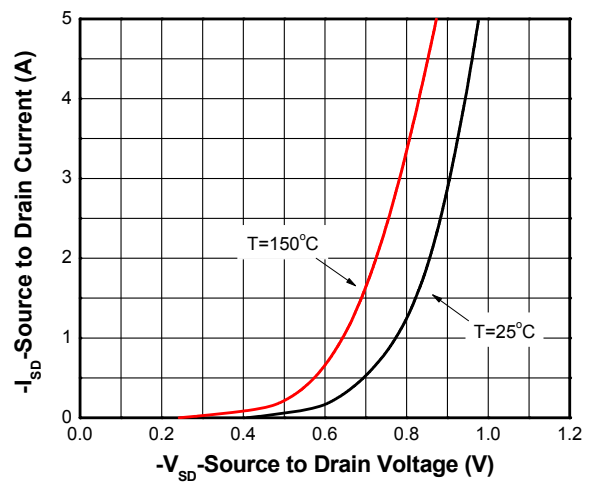
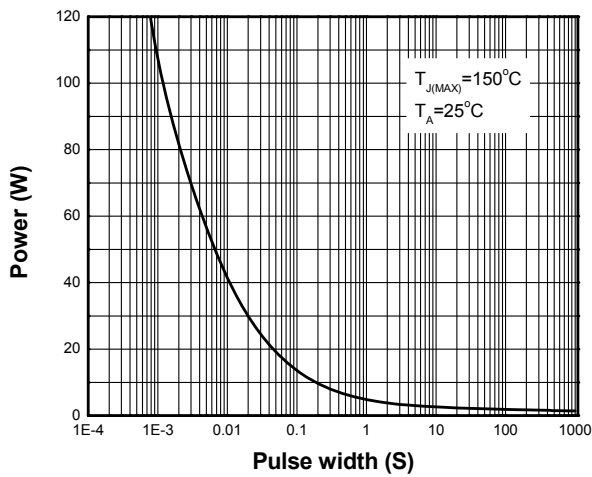
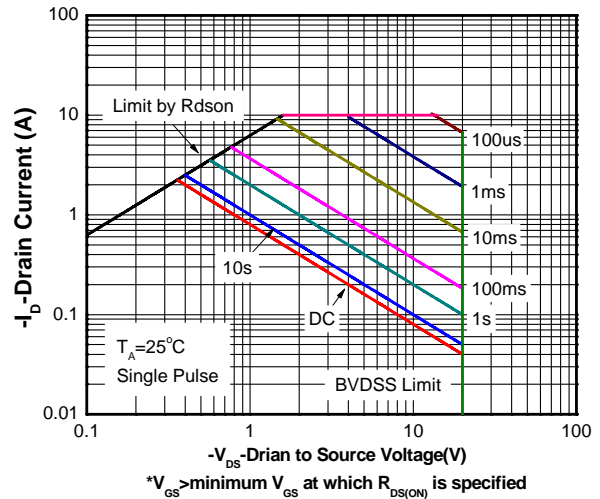
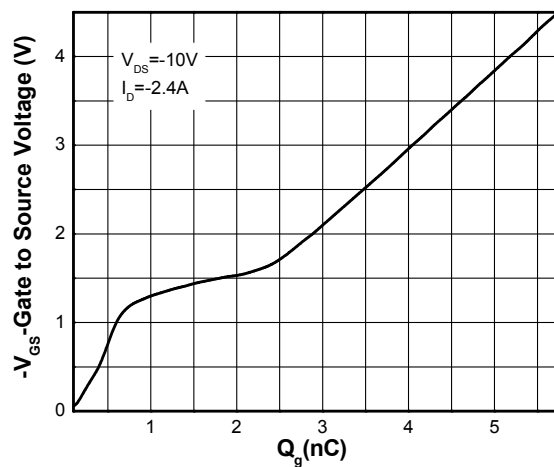
**Output characteristics**

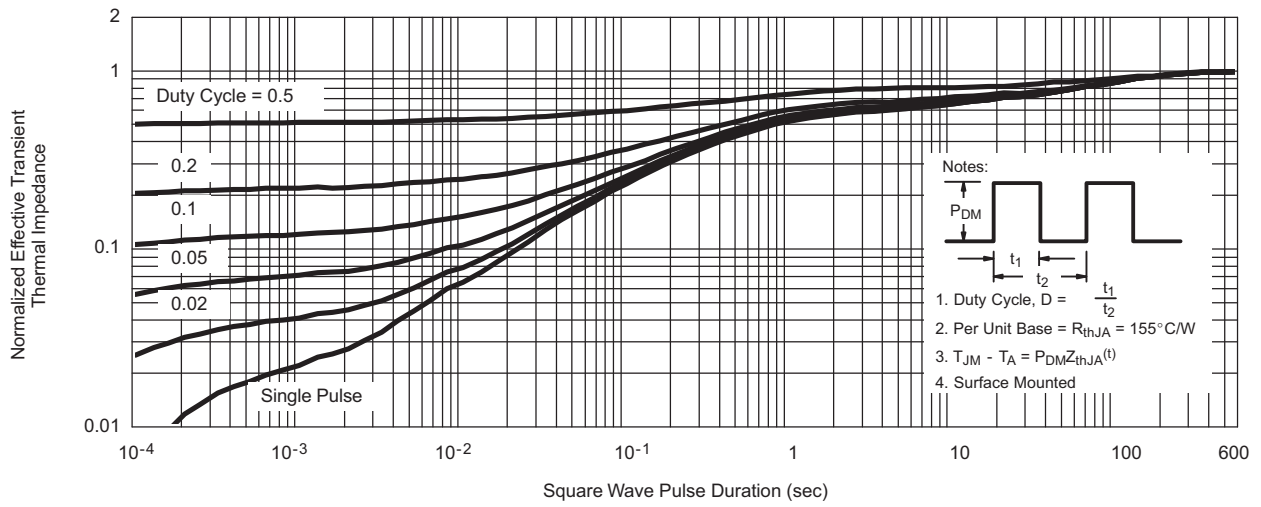
**Transfer characteristics**

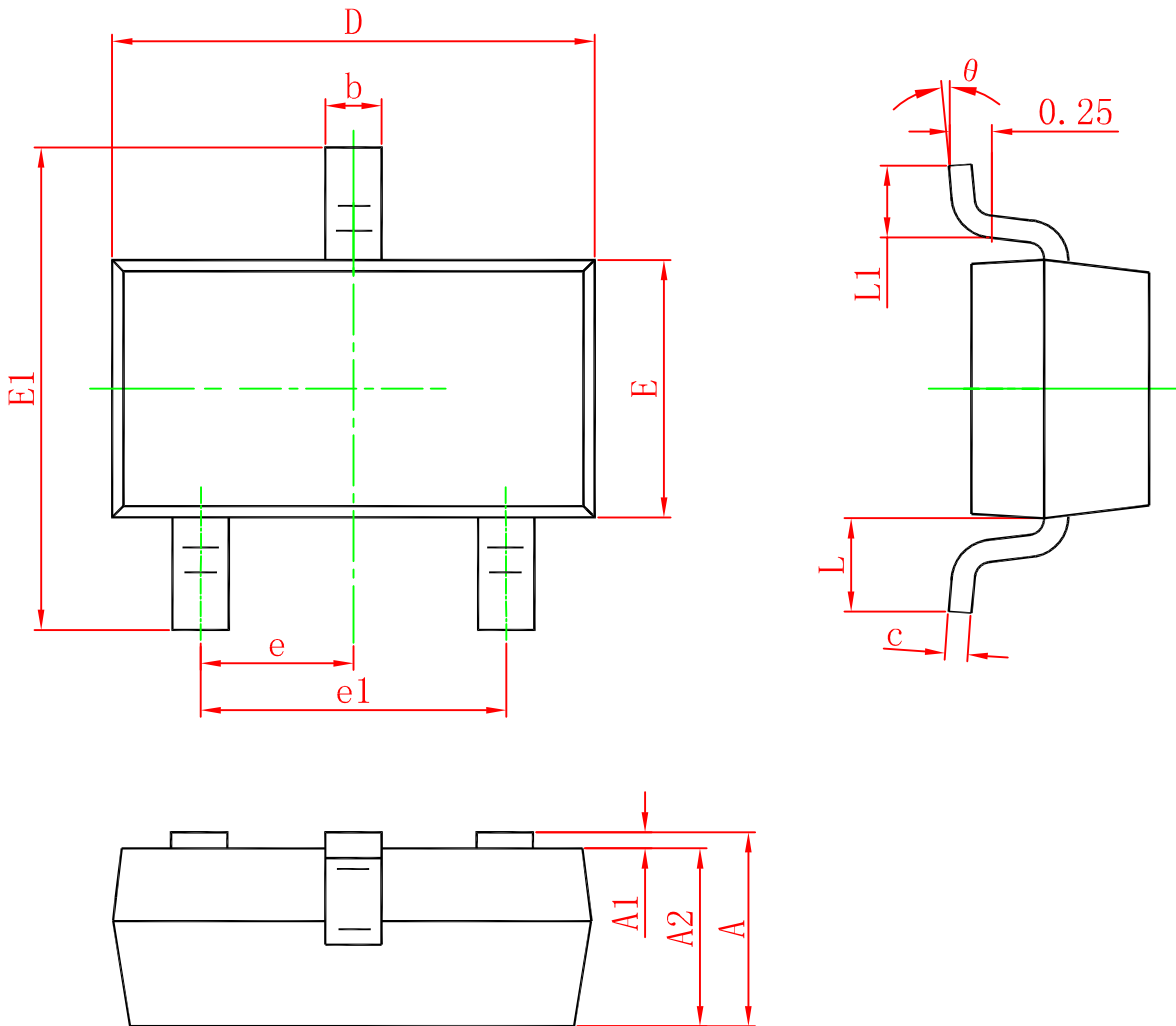
**On-Resistance vs. Drain current**

**On-Resistance vs. Gate-to-source voltage**

**On-Resistance vs. Junction temperature**

**Threshold voltage vs. Temperature**

**Capacitance**

**Body diode forward voltage**

**Single pulse power**

**Safe operating power**

**Gate Charge Characteristics**

**Transient thermal response (Junction-to-Ambient)**

**Package outline dimensions**
**SOT-23**

Symbol	Dimensions In Millimeters	
	Min.	Max.
A	0.900	1.150
A1	0.000	0.100
A2	0.900	1.050
b	0.300	0.500
c	0.080	0.150
D	2.800	3.000
E	1.200	1.400
E1	2.250	2.550
e	0.950 (Typ.)	
e1	1.800	2.000
L	0.550 (Typ.)	
L1	0.300	0.500
$\theta$	0°	8°